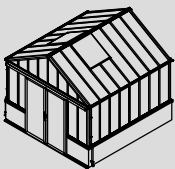
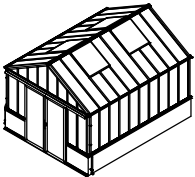
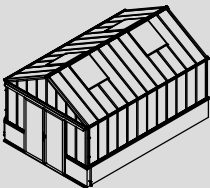
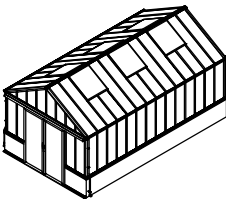
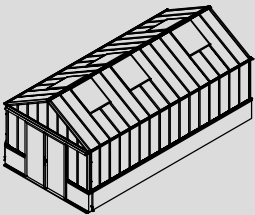

Green Room[®]

BY WILLAB GARDEN

				
3051	3052	3053	3058	3059
314×314×290cm	389×314×290cm	464×314×290cm	539×314×290cm	614×314×290cm

Product size (L×W×H):

Storlek (L×B×H):

Størrelse (L×B×H):

Størrelse (L×B×H):

Koko (P×L×K):

















Please read carefully before assembling.
Two people are needed.































Läs noggrant innan montering.
Det krävs två personer för montering.

Læs venligst omhyggeligt, før montering.
Der kræves to personer til montering.



Les monteringsanvisningen nøye innen montering.
Det kreves to personer for montering.















































Lue ohjeet huolellisesti läpi ennen asentamista.
Asentamiseen tarvitaan kaksi henkilöä.

Part	3051		3052		3053		3058		3059		QTY.	Code	Page
	NO.	Length(MM)	NO.	Length(MM)	NO.	Length(MM)	NO.	Length(MM)	NO.	Length(MM)			
	40A-Y11-4	3173	40A-Y11-5	3924	40A-Y11-6	4675	40A-Y11-7	5426	40A-Y11-8	6177	2	A001	P2
	40A-Y11-4A	2963	40A-Y11-5A	3714	40A-Y11-6A	4465	40A-Y11-7A	5216	40A-Y11-8A	5967	2	A002	P2
	40X-Y62-4NR	3132	40X-Y62-5NR	3883	40X-Y62-6NR	4634	40X-Y62-7NR	5385	40X-Y62-8NR	6136	1	A003	P4
	40A-Y62-4NL	3132	40A-Y62-5NL	3883	40A-Y62-6NL	4634	40A-Y62-7NL	5385	40A-Y62-8NL	6136	1	A004	P4
	40X-Y63-4	3118	40X-Y63-5	3869	40X-Y63-6	4620	40X-Y63-7	5371	40X-Y63-8	6122	1	A005	P6
	40X-Y14	3149	40X-Y15-5	3900	40X-Y15-6	4651	40X-Y15-7	5402	40X-Y15-8	6153	2	A006	P11
	40X-Y62-4A	3132	40X-Y62-5A	3881	40X-Y62-6A	4634	40X-Y62-7A	5385	40X-Y62-8A	6136	2	A007	P17
Part	NO.	QTY.		Length(MM)	Page	Part	NO.	QTY.		Length(MM)	Page		
		3051	3052					3053	3058			3059	
	40A-Y30	11	13	15	17	19	1235	4	8	8	12	882	P26
	40X-Y33R	2	4	4	6	6	1716						
	40X-Y33L	2	4	4	6	6	1716						
	40X-Y33-A	2	0	2	0	2	1716						
	40X-Y35	3	4	5	6	7	1000						
	40A-Y01	17	19	21	23	25	1235						
	40X-Y06	10	12	14	16	18	1756						
	40X-Y07	2	4	4	6	6	712						
	40X-Y80E-A	2	4	4	6	6	801						
												1a/30	



























Part	NO.	QTY.	Length(MM)	Page	Part	NO.	QTY.	Length(MM)	Page
	40A-Y12	1	3173	P2		40A-Y95	4	1765	P19
	40A-Y13R	1	854	P2		40A-Y96	4	668	P19
	40A-Y13L	1	854	P2		40A-Y97-A	2	1851	P21
	40A-Y12-A	1	3023	P3		40A-Y97R	1	1860	P21
	40A-Y13R-A	1	779	P3		40A-Y97L	1	1860	P21
	40A-Y13L-A	1	779	P3		40A-Y94	1	1835	P21
	40A-Y20	4	1236	P4		40A-Y98-R	1	1910	P22
	40X-Y60	1	3023	P5		40A-Y98-L	1	1910	P22
	40A-Y61	1	3023	P5		40A-Y99	1	1424	P22
	40X-Y31R	2	418	P7		40A-Y100	1	1424	P22
	40X-Y31L	2	418	P7		50A-Y64	1	3768	P23
	40X-Y32	2	859	P7		40A-Y17	1	3110	P23
	40X-Y21	2	1755	P8		40A-Y98A-R	1	1855	P23
	40X-Y22	2	1755	P8		40A-Y98A-L	1	1855	P23
	40X-Y14	1	3149	P11					
	40A-Y15-R	1	842	P11					
	40A-Y15-L	1	842	P11					
	40A-Y02	2	1235	P11					
	40X-Y03	2	859	P13~14					
	40X-Y04R	2	418	P13~14					
	40X-Y04L	2	418	P13~14					
	40X-Y05R	2	1715	P13~14					
	40X-Y05L	2	1715	P13~14					
	40X-Y60-A	1	3023	P17					
	40A-Y90	2	1866	P18					
	40A-Y91R	1	1866	P18					
	40A-Y91L	1	1866	P18					
	40A-Y92R	1	769	P18					
	40A-Y92L	1	769	P18					
	40A-Y93	2	769	P18					
				1b/30					

Part	NO.	QTY.					Length(MM)	Page
		3051	3052	3053	3058	3059		
	W06	12	20	20	28	28	46	P2~26
	J09	24	40	40	56	56	PCS	P3~25
	Si6-16	122	142	162	182	202	PCS	P4~22
	J05	135	155	175	195	215	PCS	P4~22
	S6-10	20	24	24	28	28	PCS	P8
	Mi6	20	24	24	28	28	PCS	P8
	Si5-16	8	16	16	24	24	PCS	P9
	J01	8	16	16	24	24	PCS	P9
	W04	24	32	32	40	40	PCS	P18~26
	T07	4	8	8	12	12	PCS	P27















	7C26-007N	21.5M	23M	24.5M	26M	27.5M		P12~16
	7C26-009A	5M	5M	6.5M	6.5M	8M		P16
	MCJT002	18M	25M	25M	32M	32M		P20~26

Part	NO.	QTY.	Length(MM)	Page	Part	NO.	QTY.	Length(MM)	Page
	7B26-025	8	PCS	P2		7C33-S03	4	PCS	P29
	PS8-80	16	PCS	P3		Z4.8-25	4	PCS	P29
	7B26-017	4	PCS	P4		7C33-S04	2	PCS	P29
	M6-8	24	PCS	P4~8		J07-A	2	PCS	P29
	J08	1	PCS	P4		J07-B	2	PCS	P29
	7B26-029	4	PCS	P6		T09	2	PCS	P30
	M6-20	8	PCS	P6		T10	4	PCS	P30
	7B26-033	4	PCS	P8		T10A	4	PCS	P30
	7B26-005	4	PCS	P8					
	Si6-12	4	PCS	P8		L06	8	1400	P5~6
	W03	8	30	P18		L03	4	1830	P8
	Z4.2-13	42	PCS	P21~30		NSST120	1.9M		P21
	T04	2	PCS	P21		7C26-S01A	2	1900	P29
	Z4.2-38	3	PCS	P21					
	Z3.5-25	8	PCS	P21~25		TOOLS	1	PCS	
	M6-35	2	PCS	P22			1	PCS	
	Si6-35	6	PCS	P22			1	PCS	
	PS6-80	2	PCS	P22			1	PCS	
	7C28-004	5	PCS	P23			1	PCS	
	Z4.2-50	5	PCS	P23					
	Si6-25	3	PCS	P23					
	7C26-031	2	PCS	P23					
	T01	1	PCS	P25					
	T01A	1	PCS	P25					
	J02	2	PCS	P25					
	7B26-039	2	PCS	P25					
	7B26-038	2	PCS	P25					
	M4-40	2	PCS	P25					
	Mi4-17	2	PCS	P25					
	7C33-S02	2	PCS	P28					
				1d/30					

3140P-S



























Part	NO.	QTY.	Length(MM)	Page	Part	NO.	QTY.	Length(MM)	Page
	40A-Y30	14	1235	P7		7B26-011	50	PCS	P2~8
	50X-Y31R	2	633	P7		Ma6-12	50	PCS	P2~8
	50X-Y31L	2	633	P7		M6	50	PCS	P2~8
	40X-Y31A-R	2	201	P7		Si6-16	100	PCS	P4~22
	40X-Y31A-L	2	201	P7		J05	100	PCS	P4~22
	40X-Y34A	2	713	P9		S6-10	32	PCS	P8
	40X-Y33-B	6	1716	P9		7B26-005	8	PCS	P8
	40X-Y33-C	2	839	P9		Mi6	32	PCS	P8
	40A-Y01	14	1235	P11		Si5-16	4	PCS	P9
	50X-Y04R	2	633	P13~14		J01	4	PCS	P9
	50X-Y04L	2	633	P13~14					
	40X-Y04A-R	2	201	P13~14		TOOL-009	1	341	
	40X-Y04A-L	2	201	P13~14					
	40X-Y06	6	1756	P15					
	40X-Y06A	2	878	P15					
	40X-Y82E-A	2	801	P26					









3140P-S-2

Part	NO.	QTY.	Length(MM)	Page	Part	NO.	QTY.	Length(MM)	Page
	40A-Y30	4	1235	P7		7B26-011	14	PCS	P2~8
	40X-Y34A	2	713	P9		Ma6-12	14	PCS	P2~8
	40X-Y33-C	2	839	P9		M6	14	PCS	P2~8
	40X-Y33-B	2	1716	P9		Si6-16	28	PCS	P4~22
	40A-Y01	4	1235	P11		J05	28	PCS	P4~22
	40X-Y06	2	1756	P15		Si5-16	4	PCS	P9
	40X-Y06A	2	878	P15		J01	4	PCS	P9
	40X-Y82E-A	2	801	P26					

NO.	QTY.				
	3051	3052	3053	3058	3059
3140P-S	1	1	1	1	1
3140P-S-2	0	1	1	2	2

Spare Part Bag For Green Room Wall

Part	NO.	QTY.	Length(MM)	Page	Part	NO.	QTY.	Length(MM)	Page
	7B26-025	2	PCS	P2		Z4.2-38	2	PCS	P21
	J09	6	PCS	P2~25		Z3.5-25	2	PCS	P21~25
	M6-8	4	PCS	P3~7		M6-35	2	PCS	P22
	Si6-16	10	PCS	P3~22		Si6-35	2	PCS	P22
	J05	10	PCS	P3~22		7C28-004	2	PCS	P23
	M6-20	2	PCS	P4		Z4.2-50	2	PCS	P23
	S6-10	4	PCS	P7		Si6-25	2	PCS	P23
	7B26-033	2	PCS	P7		7C26-031	2	PCS	P23
	Mi6	4	PCS	P7		M4-40	2	PCS	P25
	Si6-12	2	PCS	P7		Mi4-17	2	PCS	P25
	Si5-16	4	PCS	P8		T07	2	PCS	P27
	J01	4	PCS	P8		Z4.8-25	2	PCS	P29
	W04	4	PCS	P18~26		J07-A	2	PCS	P29
	Z4.2-13	4	PCS	P21~30					

Part	NO.	QTY.					Length(MM)	Page
		3051	3052	3053	3058	3059		
	354×1262	28	32	36	40	44	1262	P10
	324×203	4	4	4	4	4	324	P13-14
	354×420	4	4	4	4	4	420	P13-14
	354×635	4	4	4	4	4	635	P13-14
	354×852	4	4	4	4	4	852	P13-14
	354×1764	12	12	16	16	20	1764	P15
	354×887	4	8	8	12	12	887	P15
	659×1756	2	2	2	2	2	1756	P19
	782×863	2	4	4	6	6	863	P26

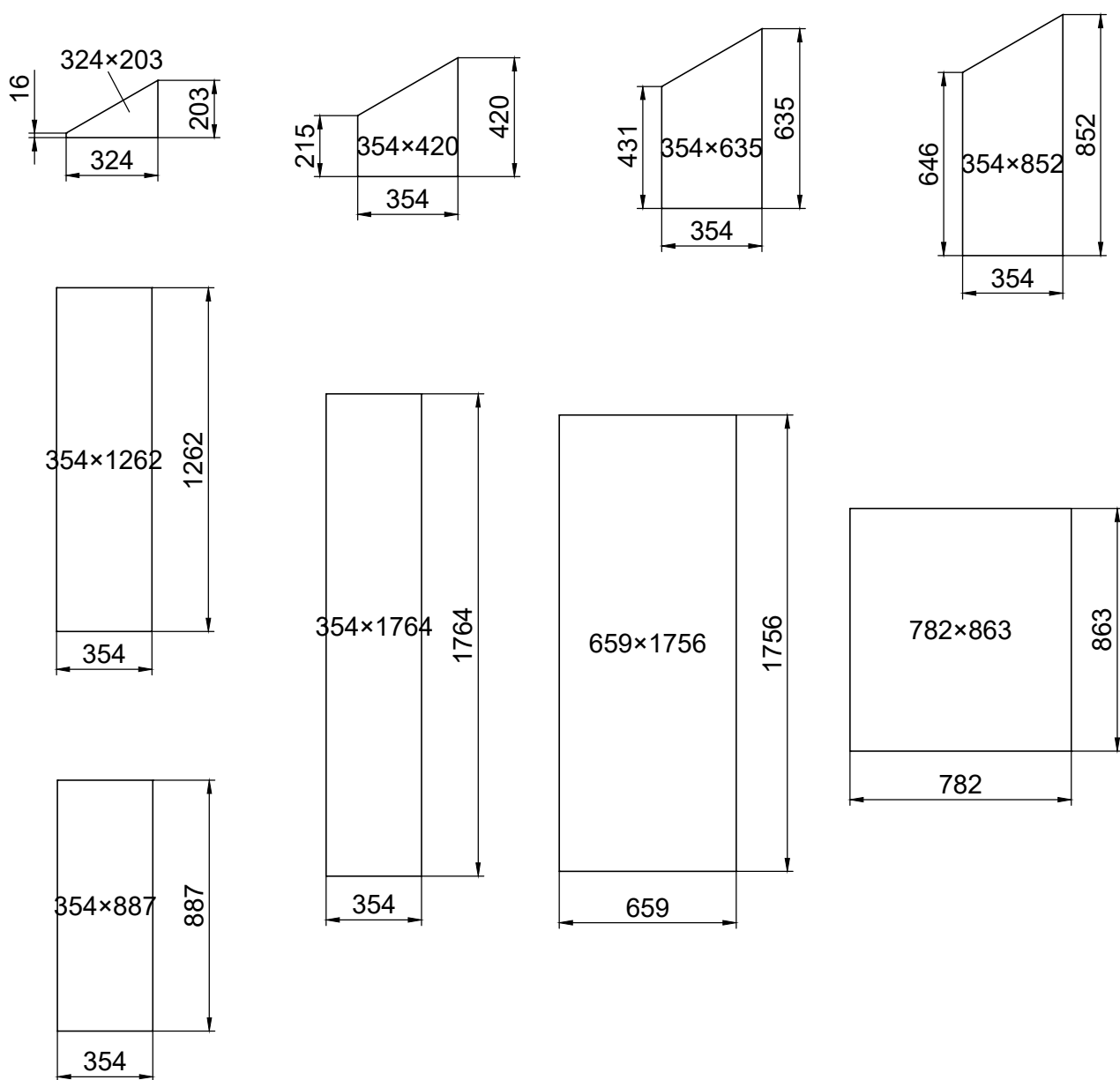

Code	Length(MM)				
		3051	3052	3753	3058
L	3139	3890	4641	5392	6143

Sealing should be done to prevent frost from destroying the wall. The sealant between the wall and foundation of the greenhouse is provided and handled by customers themselves.

Tätning bör göras för att muren ej skall frostsprängas. Tätning mellan mur och sockel står kunden själv för.

Tætningen bør gøres for at forhindre frostsprængninger i muren. Tætningen mellem mur og aluminiumprofil står kunden selv for

En tetning bør lages for å hindre frostsprengning av muren. Tetning mellom mur og sokkel ordnes av kunden selv

Tiivistys täytyy tehdä, jotta muuri ei hajoa pakkasella. Tiiviste muurin ja sokkelin välissä täytyy asiakkaan hoitaa itse

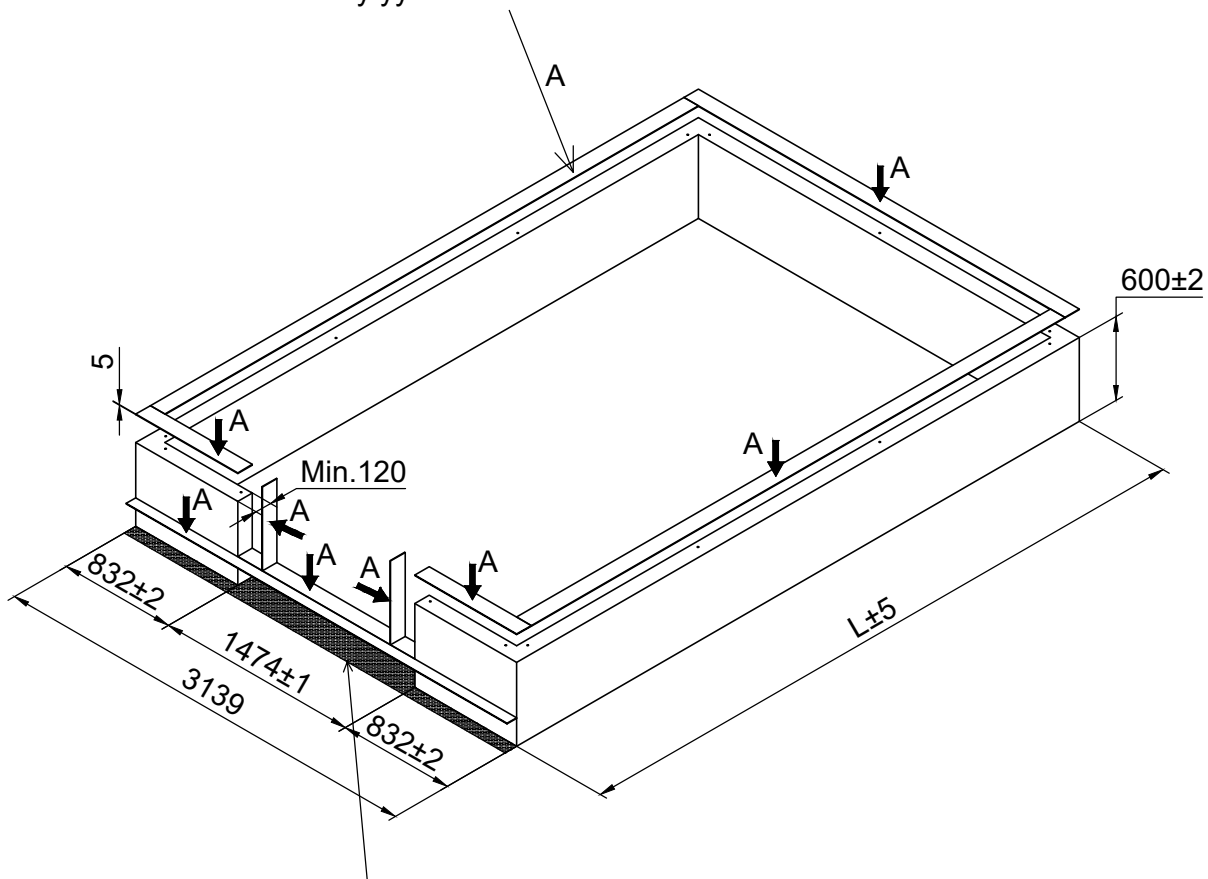

Make sure the floor below the doors frame should be flat and solid.

Se till att underlaget under dörramen är plan och på solid grund.

Sørg for, at underlaget under dørkarmen er plan og på fast grund.

Sørg for at underlaget under dørterskelen er slett og på solid fundament.

Tarkista, että maa ovikarmin alla on sileä ja tasainen.

L TOOL-009(341MM)

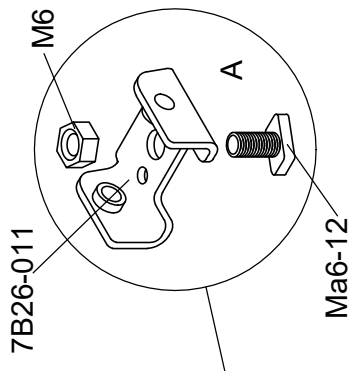
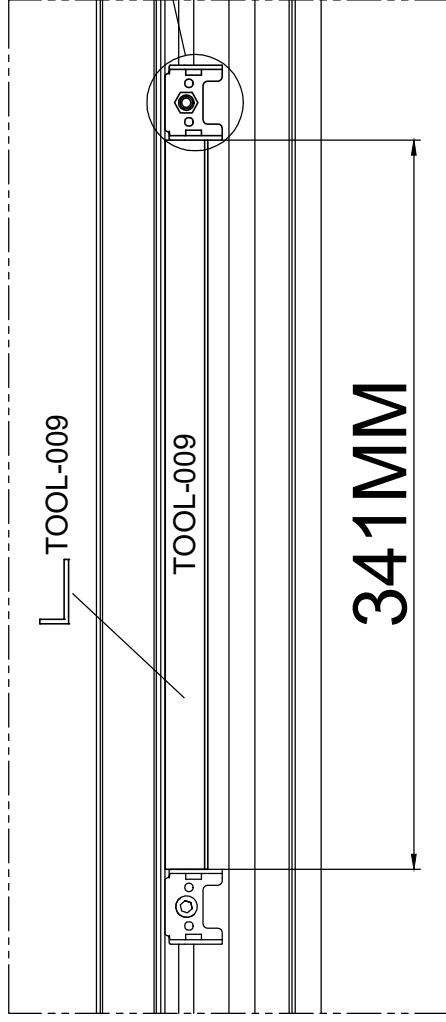
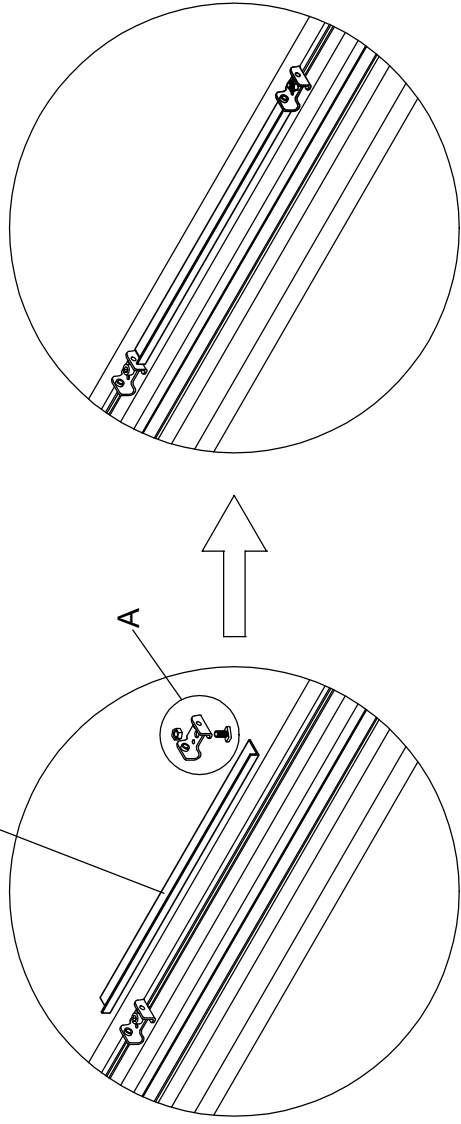

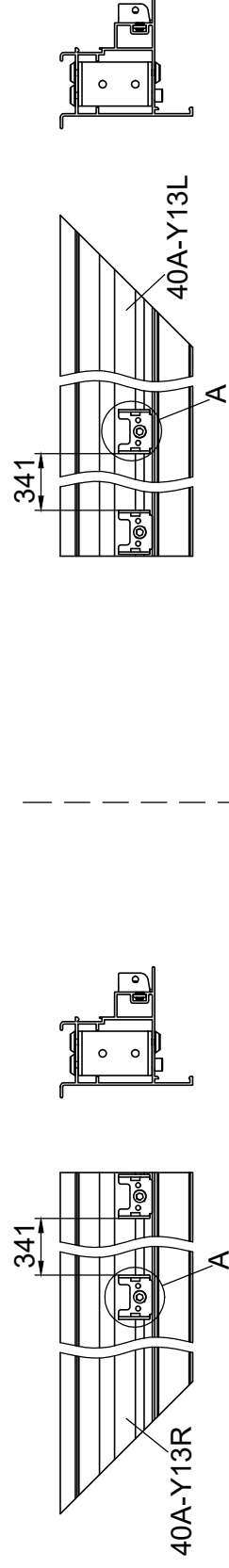
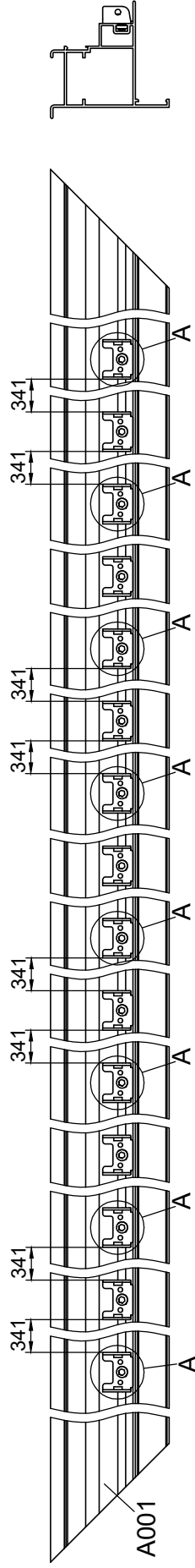
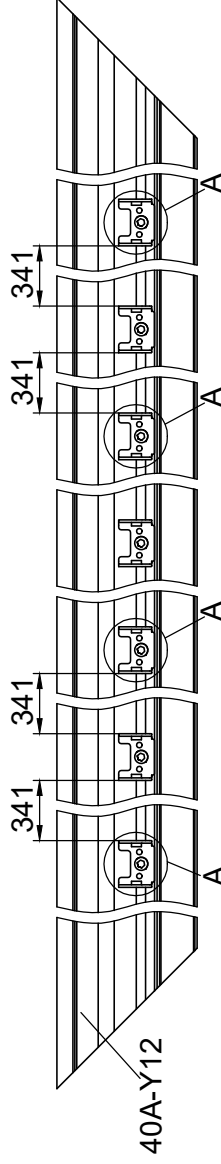
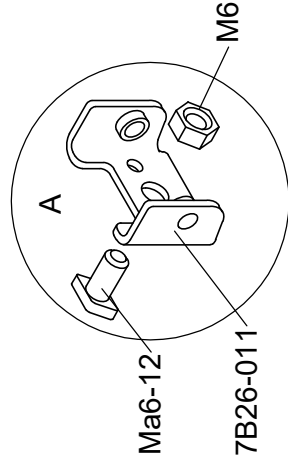

Part	Product	NO.	Length (MM)	QTY.	Code	QTY.						Length (MM)		
						3051		3052		3053			3058	
	3051	40A-Y11-4	3173			3140P -S	3140P -S-2	3140P -S	3140P -S-2	3140P -S	3140P -S-2	3140P -S	3140P -S-2	
	3052	40A-Y11-5	3924											
	3053	40A-Y11-6	4675	2	A001	14	0	14	2	14	4	14	6	8
	3058	40A-Y11-7	5426			14	0	14	2	14	4	14	6	8
	3059	40A-Y11-8	6177			14	0	14	2	14	4	14	6	8

Part	NO.	QTY.	Length(MM)
	40A-Y12	1	3173
	40A-Y13R	1	854
	40A-Y13L	1	854



2c/30

Part	NO.	QTY.	Length(MM)
	7B26-025	8	PCS
	W06	4	46

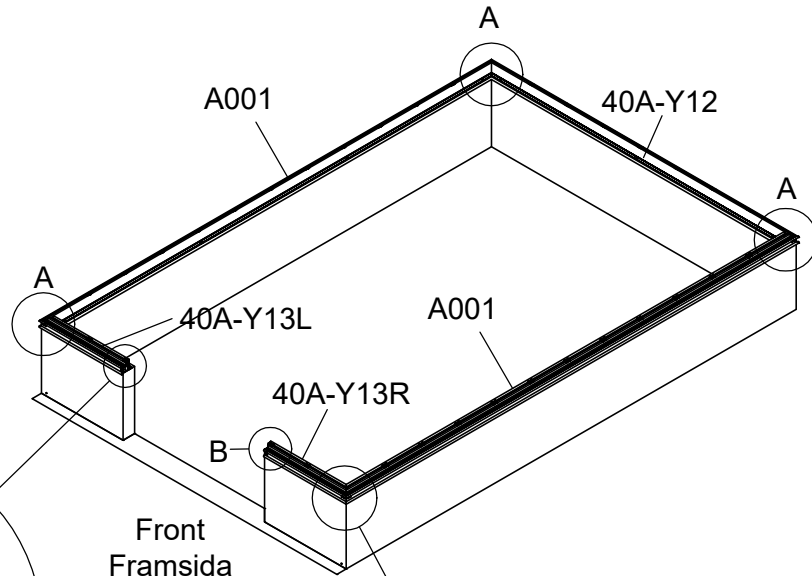

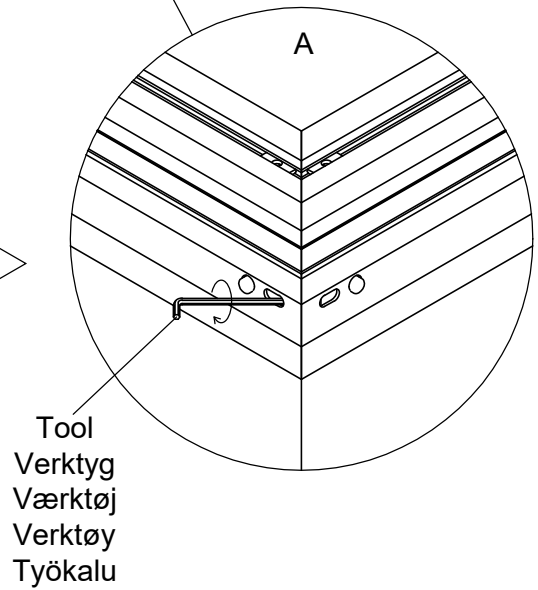
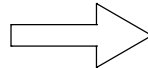
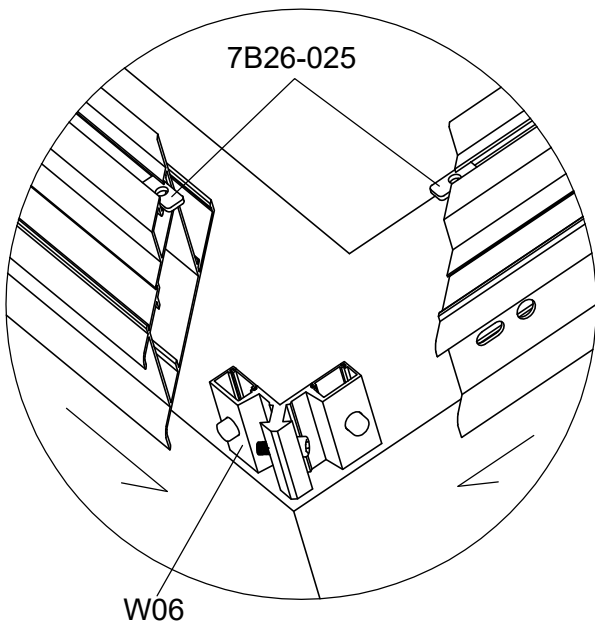
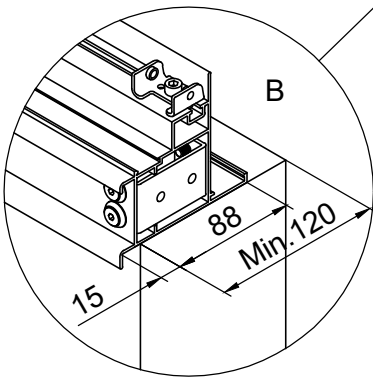

Front
Framsida
Forside
Framsida
Etupuoli

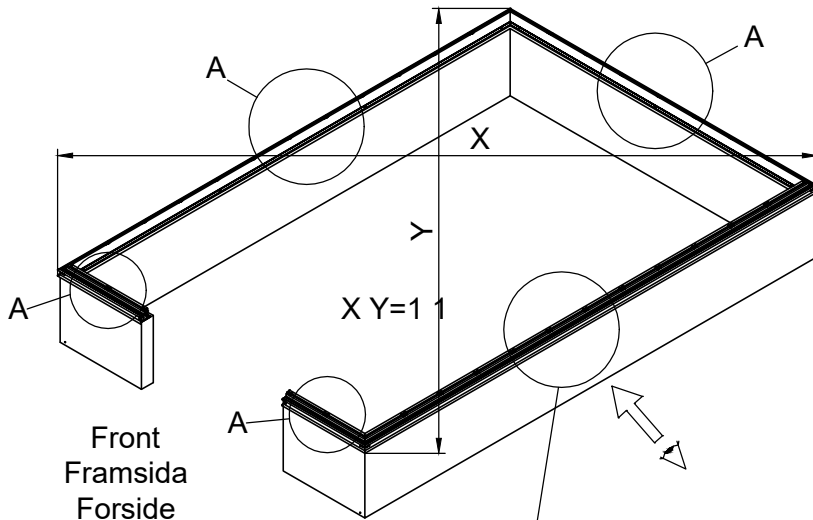



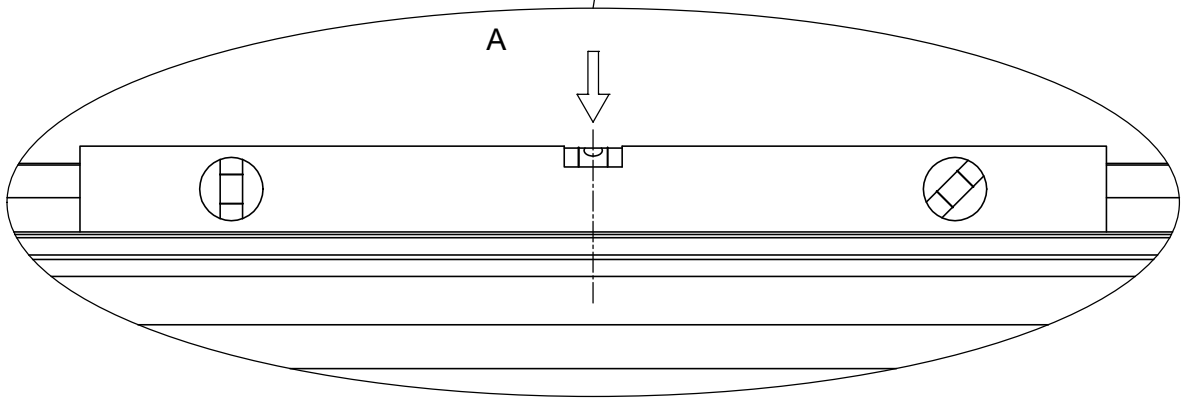



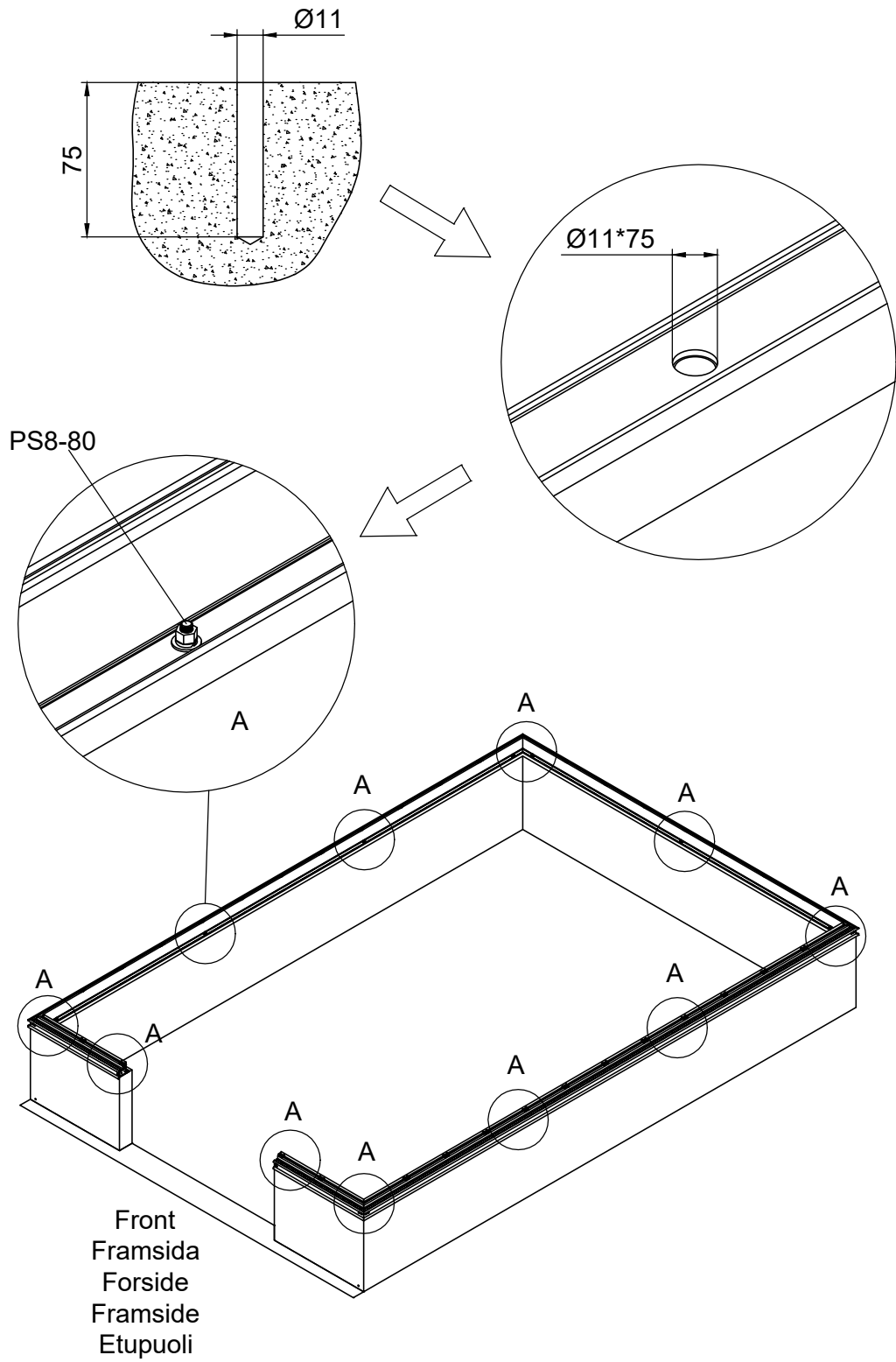

Front
 Framsida
 Forside
 Framside
 Etupuoli



Part	NO.	QTY.	Length(MM)
	PS8-80	15	PCS



Part	NO.	QTY.	Length(MM)
	40A-Y12-A	1	3023
	40A-Y13R-A	1	779
	40A-Y13L-A	1	779
	J09	8	PCS

Part	Product	NO.	Length (MM)	QTY.	Code
	3051	40A-Y11-4A	2963	2	A002
	3052	40A-Y11-5A	3714		
	3053	40A-Y11-6A	4465		
	3058	40A-Y11-7A	5216		
	3059	40A-Y11-8A	5967		

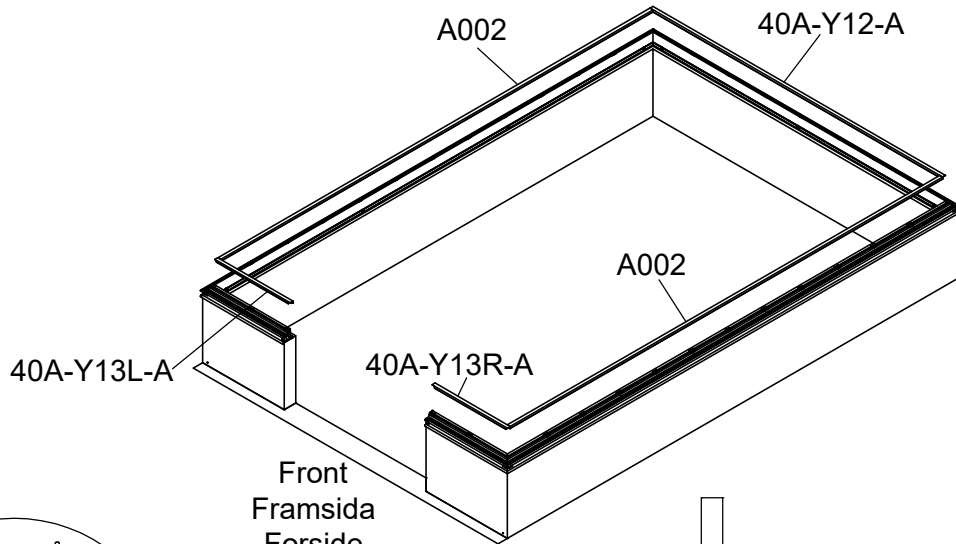

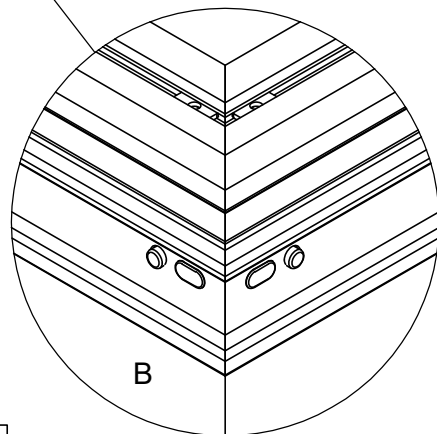
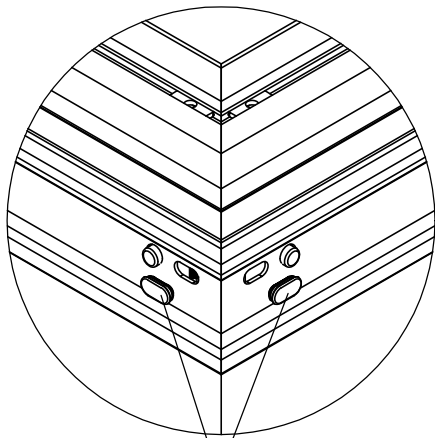
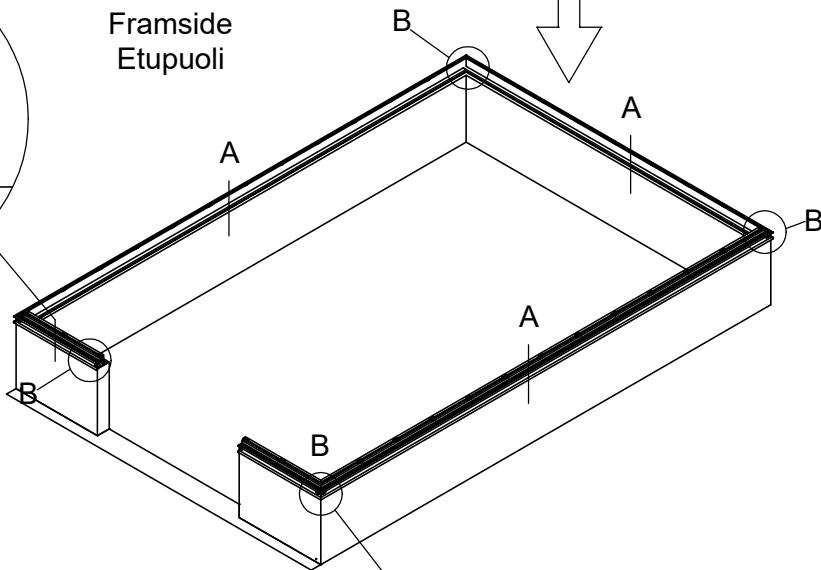
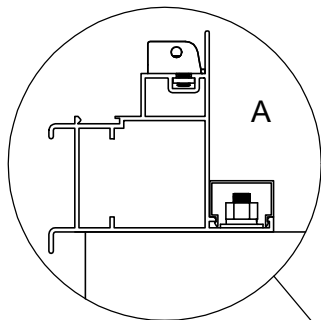

Front
Framsida
Forside
Framsida
Etupuoli



J09



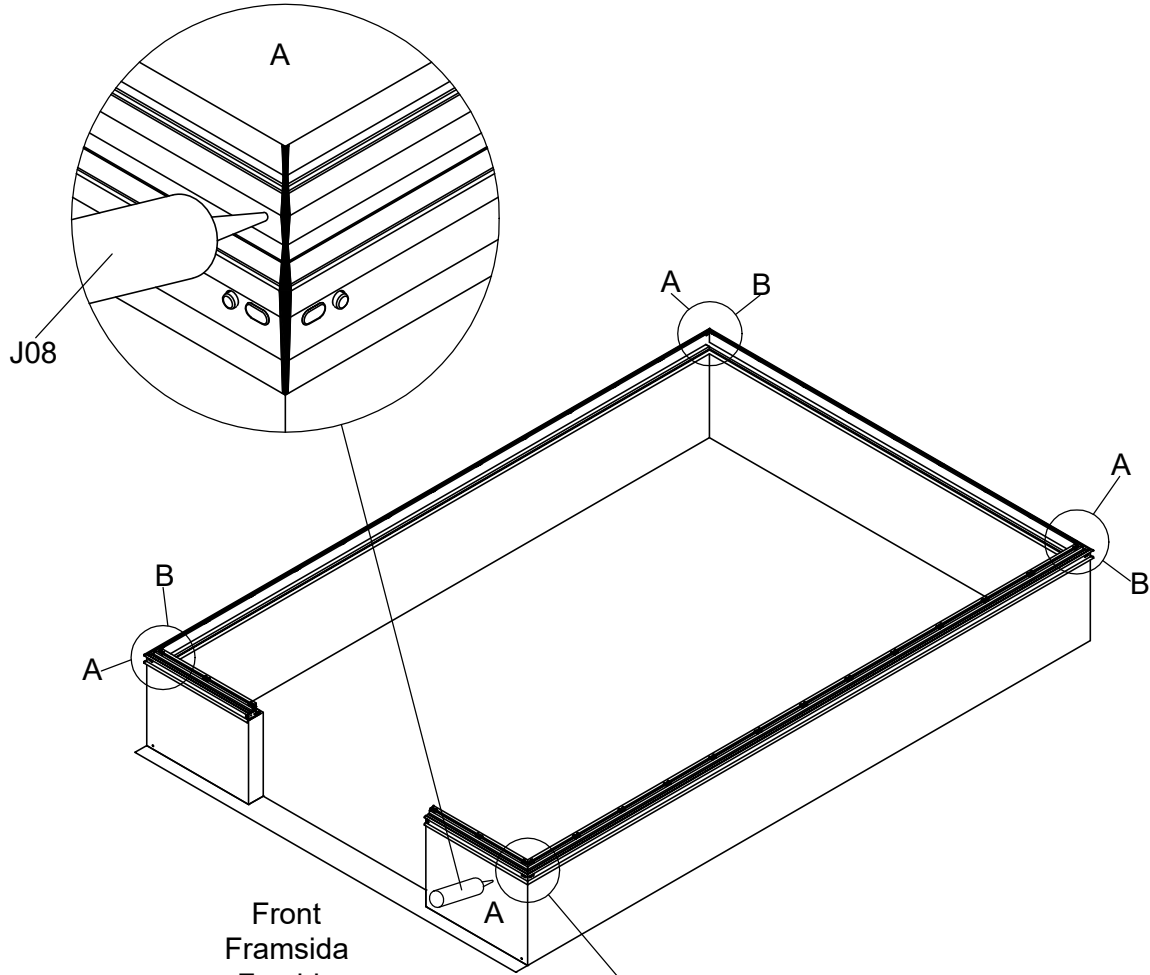

3c/30

Part	NO.	QTY.	Length(MM)
	7B26-017	4	PCS
	M6-8	8	PCS
	J08	1	PCS

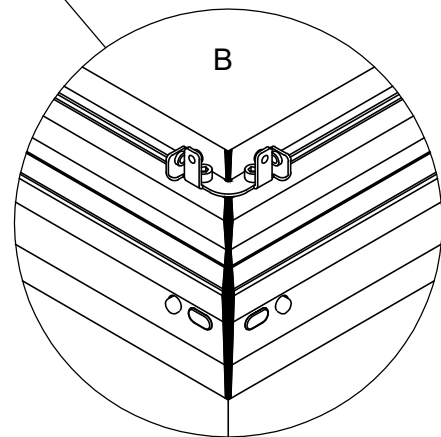
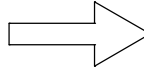
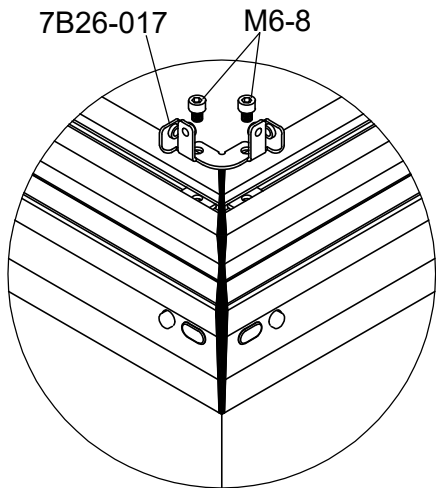





Front
 Fransida
 Forside
 Franside
 Etupuoli

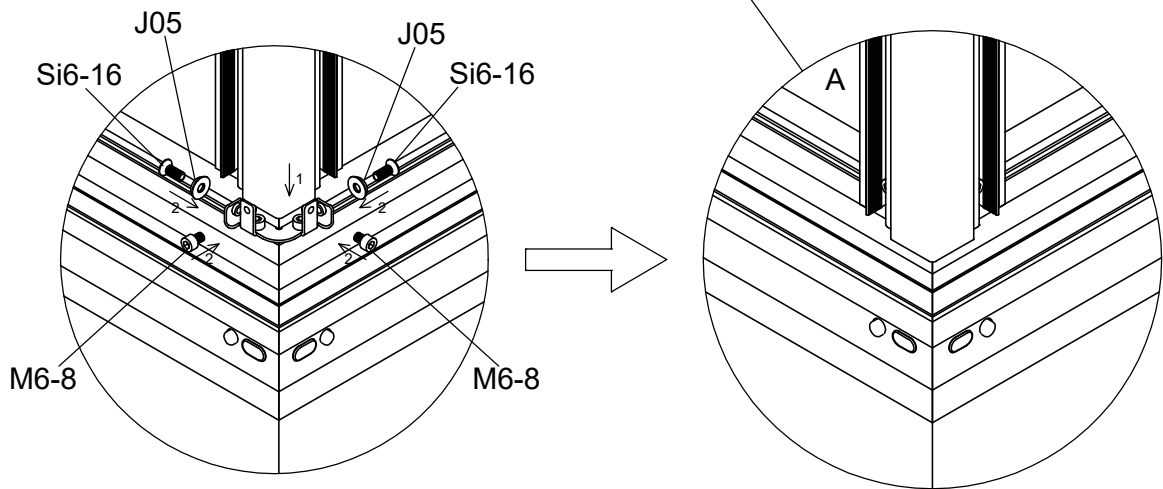
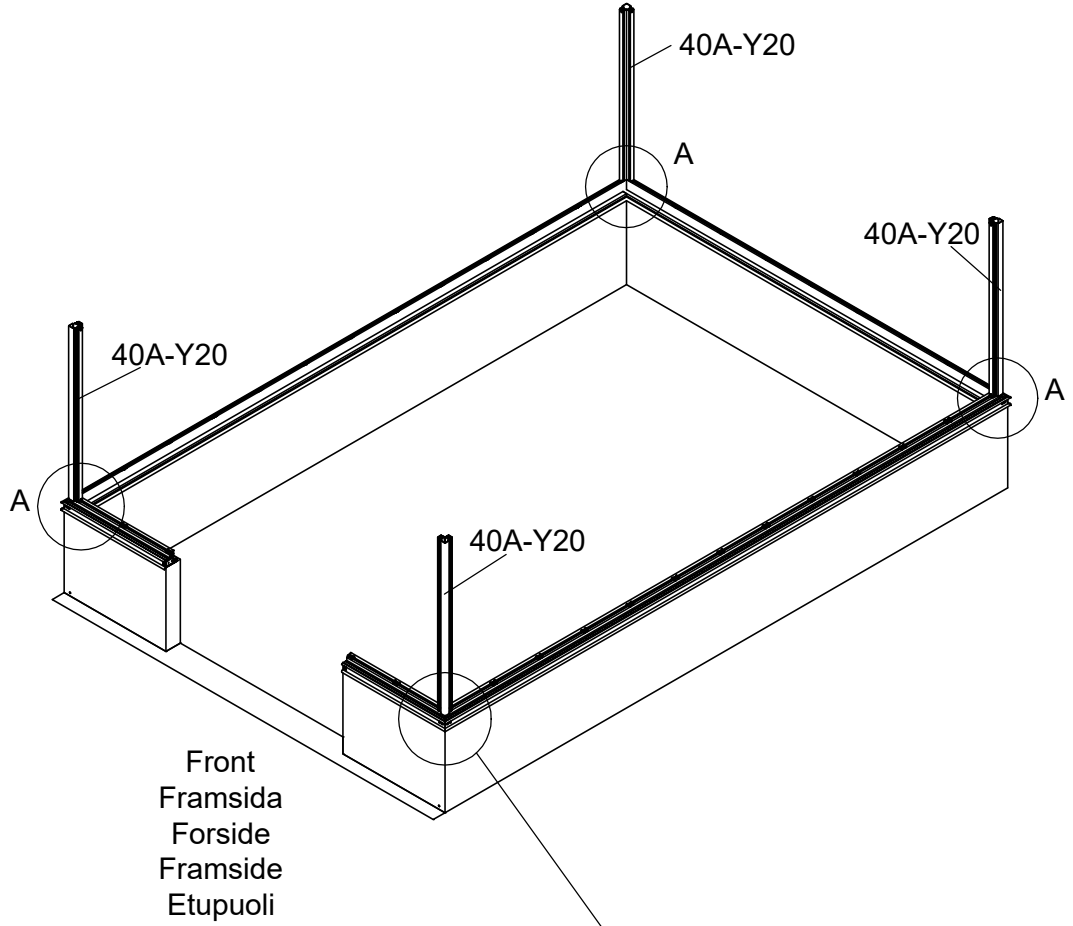



Part	NO.	QTY.	Length(MM)
	40A-Y20	4	1236
	Si6-16	8	PCS
	J05	8	PCS
	M6-8	8	PCS



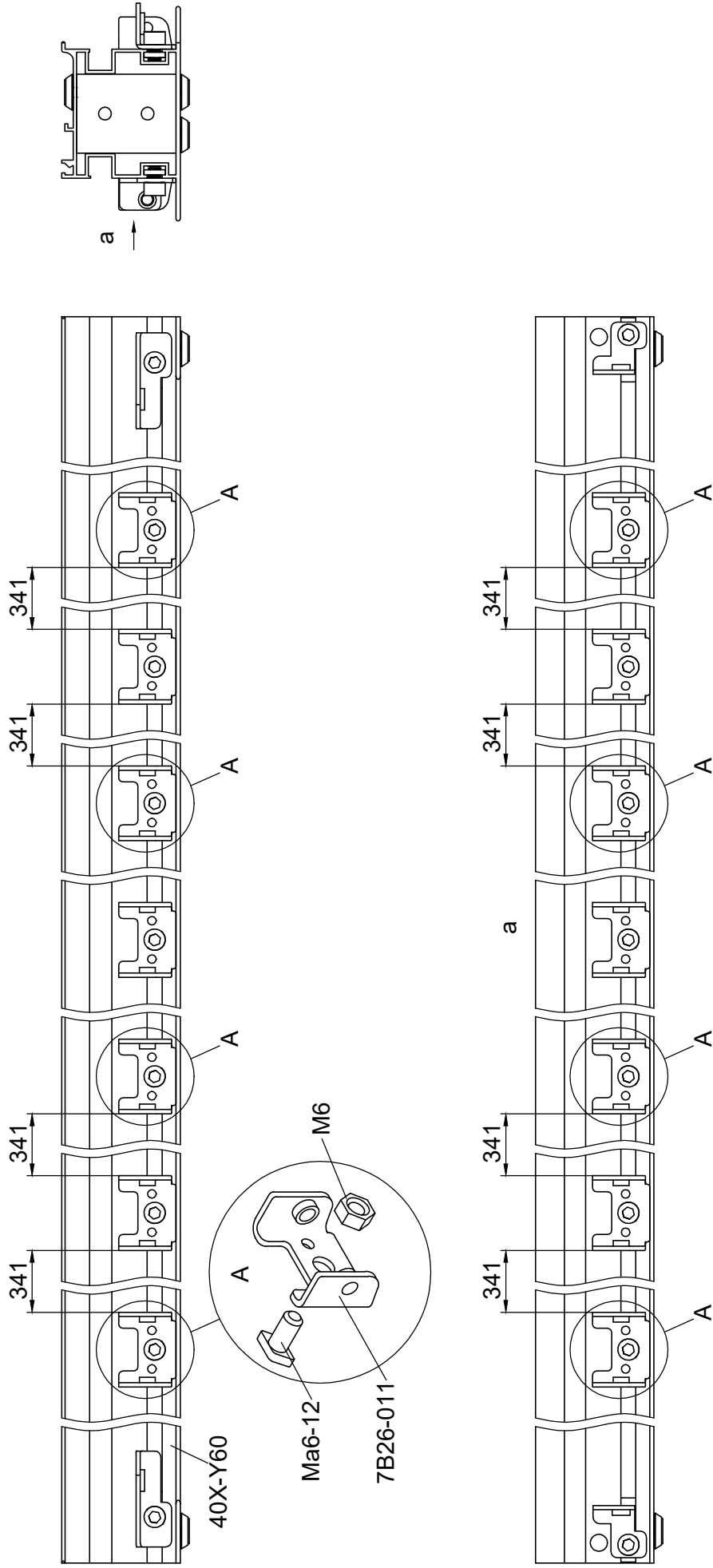

Part	NO.	QTY.	Length(MM)
	40X-Y60	1	3023



Part	NO.	QTY.	Length(MM)	CTN NO.
	Ma6-12	8	PCS	3140P-S
	7B26-011	8	PCS	3140P-S
	M6	8	PCS	3140P-S

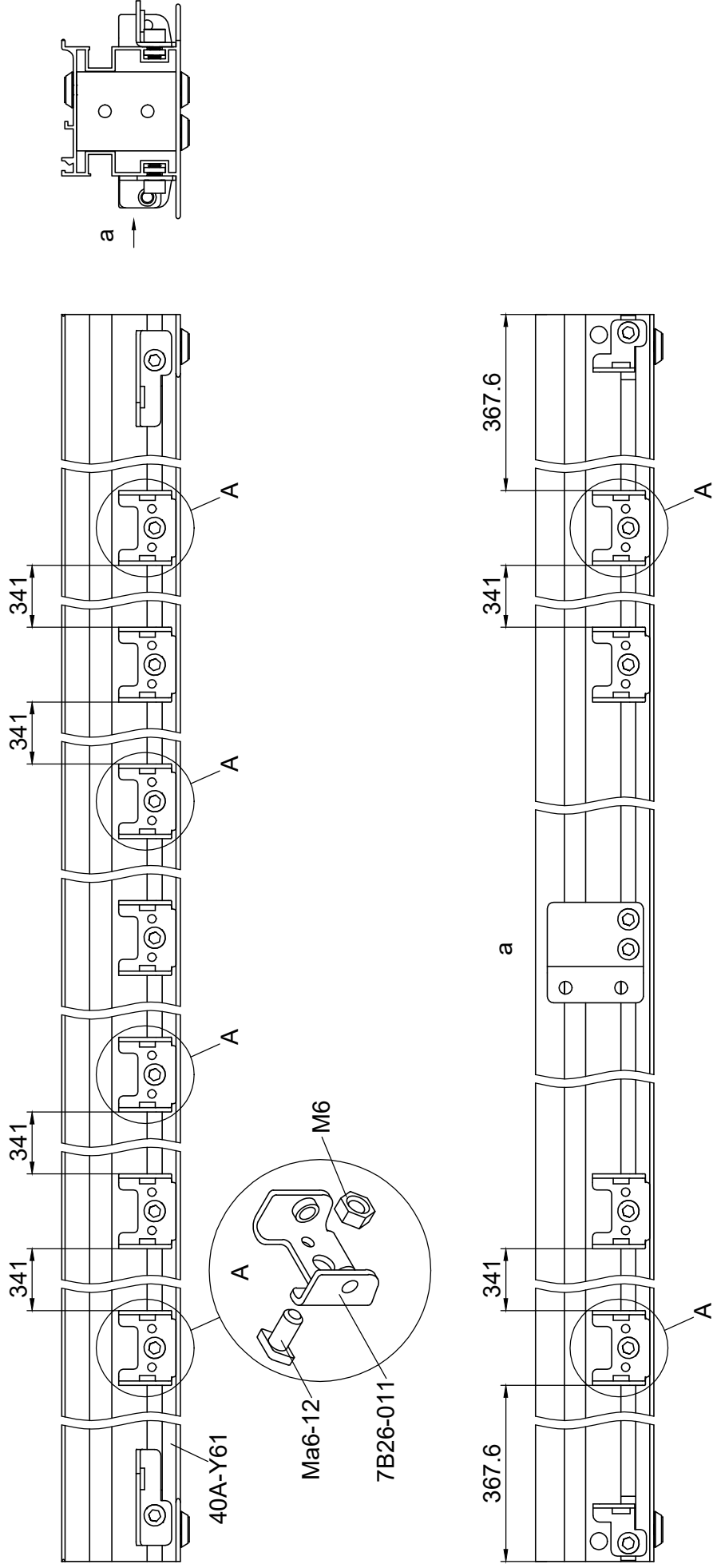

Part	NO.	QTY.	Length(MM)
	40A-Y61	1	3023

Part	NO.	QTY.	Length(MM)	CTN NO.
	Ma6-12	6	PCS	3140P-S
	7B26-011	6	PCS	3140P-S
	M6	6	PCS	3140P-S



Part	NO.	QTY.	Length(MM)
	Si6-16	4	PCS
	J05	4	PCS
	L06	4	1400

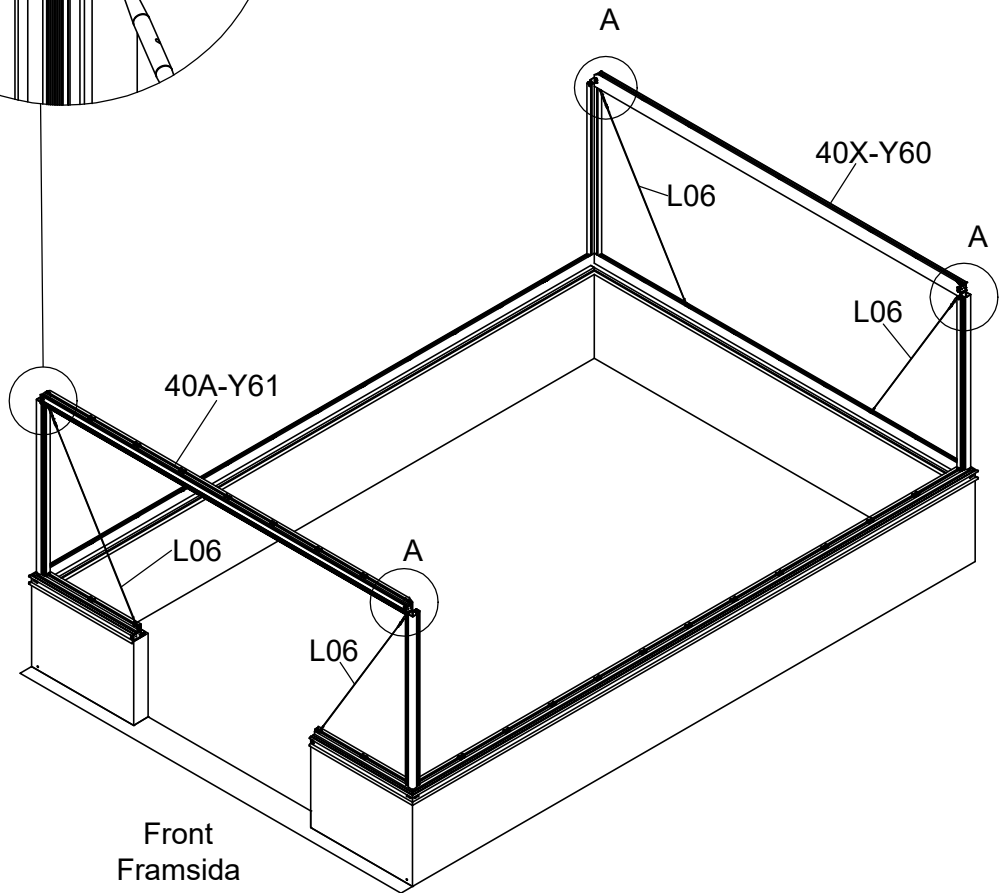
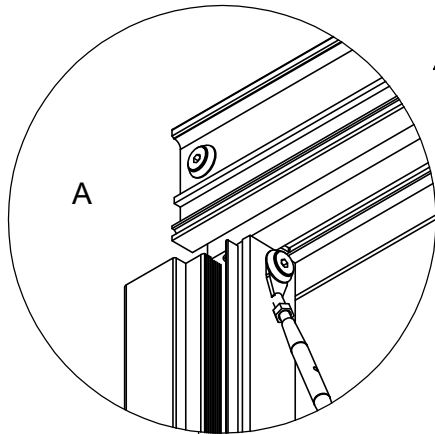
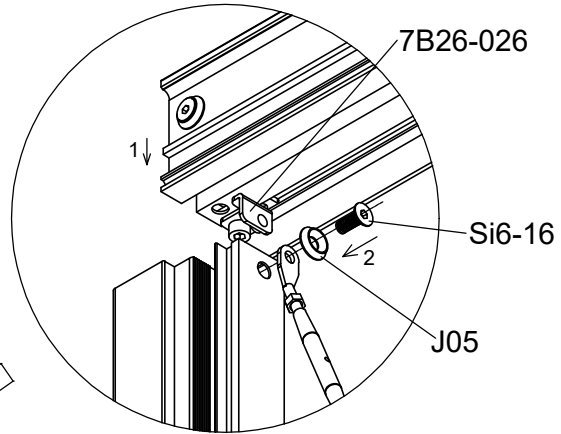



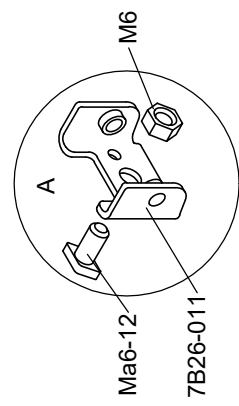
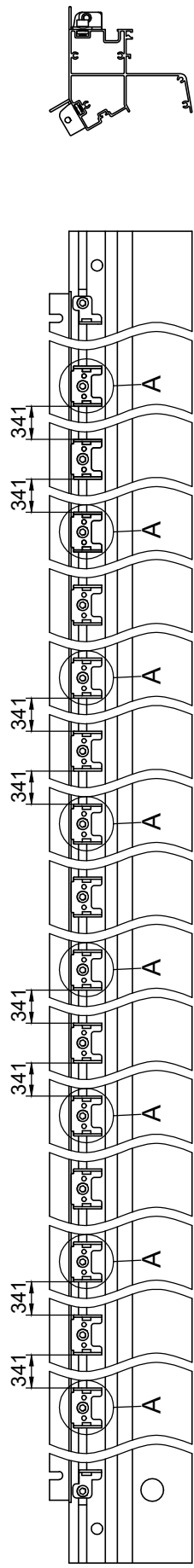
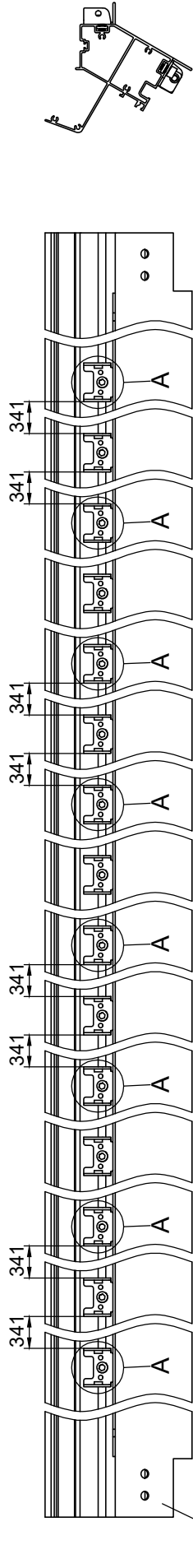

Front
 Framsida
 Forside
 Framside
 Etupuoli

Part	Product	NO.	Length (MM)	QTY.	Code	QTY.								Length (MM)		
						3051		3052		3053		3058			3059	
	3051	40X-Y62-4NR	3173			3140P -S	3140P -S-2	3140P -S	3140P -S-2	3140P -S	3140P -S-2	3140P -S	3140P -S-2	3059	3140P -S	3140P -S-2
	3052	40X-Y62-5NR	3924			8	0	2	8	4	8	8	6	8	8	8
	3053	40X-Y62-6NR	4675	1	A003	8	0	8	8	8	4	8	6	8	8	8
	3058	40X-Y62-7NR	5426			8	0	2	8	4	8	8	6	8	8	8
	3059	40X-Y62-7NR	6177			8	0	2	8	4	8	8	6	8	8	8

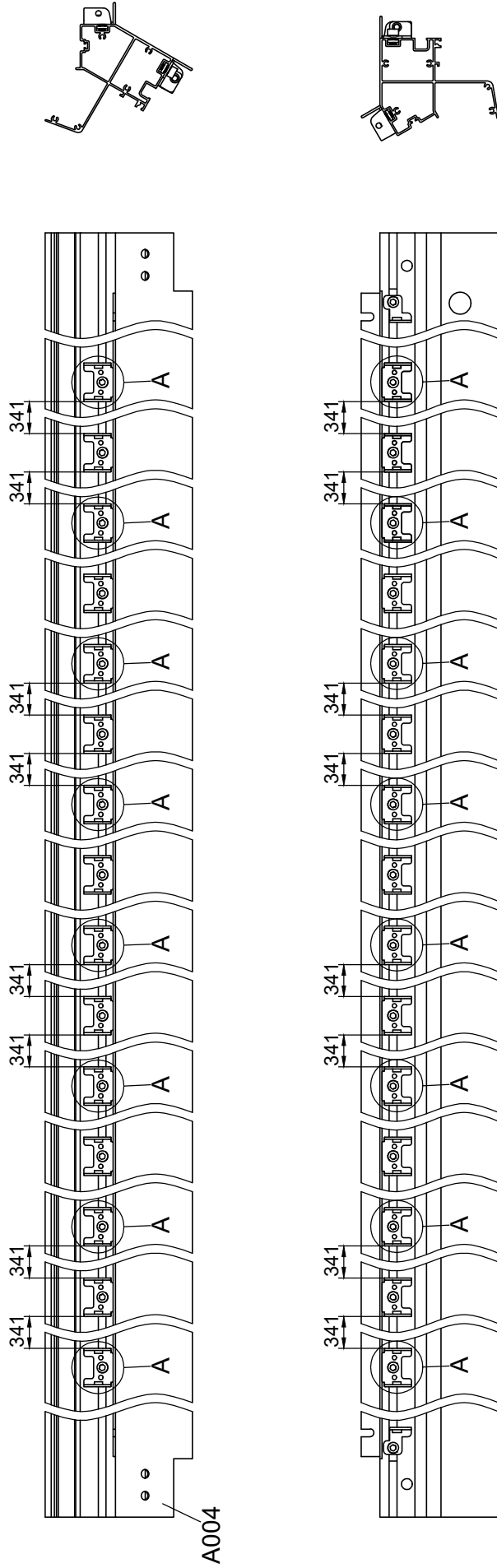

Part	Product	NO.	Length (MM)	QTY.	Code	QTY.								Length (MM)		
						3051		3052		3053		3058			3059	
	3051	40X-Y62-4NL	3173			3140P -S	3140P -S-2	3140P -S	3140P -S-2	3140P -S	3140P -S-2	3140P -S	3140P -S-2	3059	3140P -S	3140P -S-2
	3052	40X-Y62-5NL	3924			8	0	8	2	8	4	8	6	8	8	8
	3053	40X-Y62-6NL	4675	1	A004	8	0	8	2	8	4	8	6	8	8	8
	3058	40X-Y62-7NL	5426			8	0	8	2	8	4	8	6	8	8	8
	3059	40X-Y62-7NL	6177			8	0	8	2	8	4	8	6	8	8	8



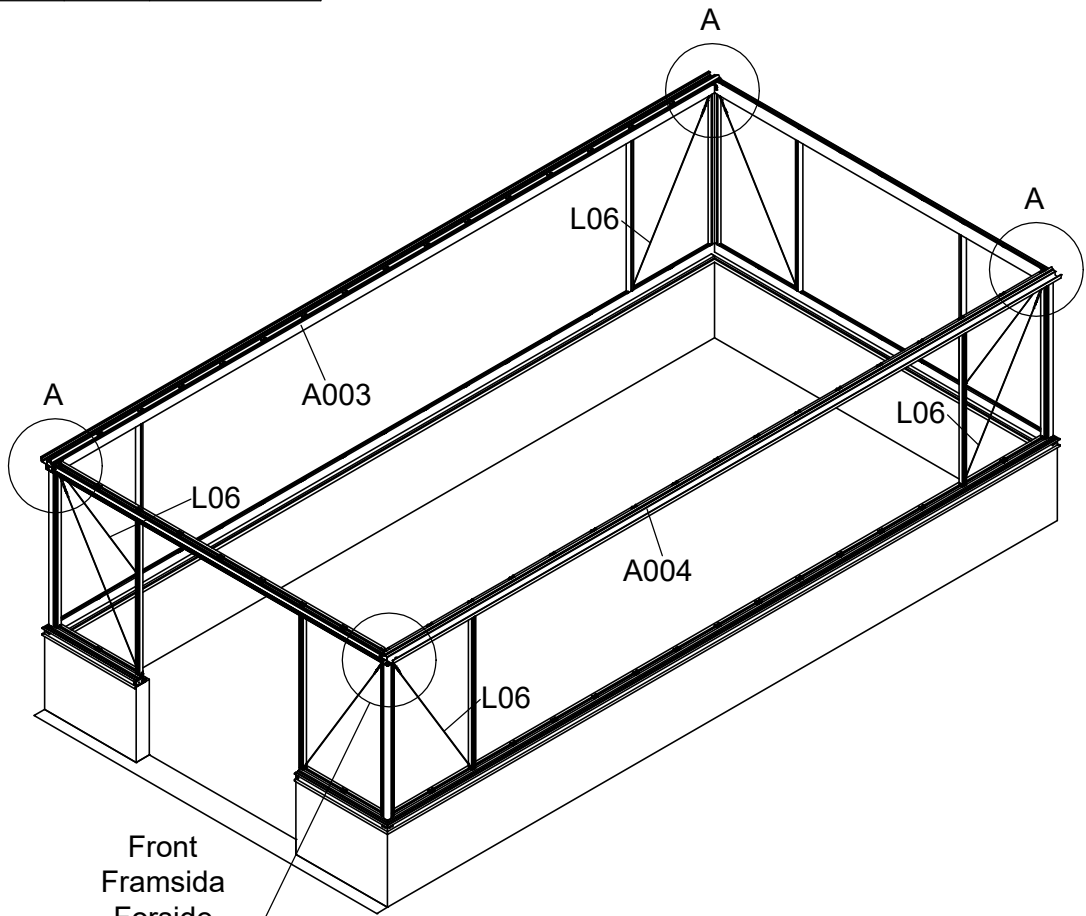

Part	NO.	QTY.	Length(MM)
	Si6-16	4	PCS
	J05	4	PCS
	L06	4	1400

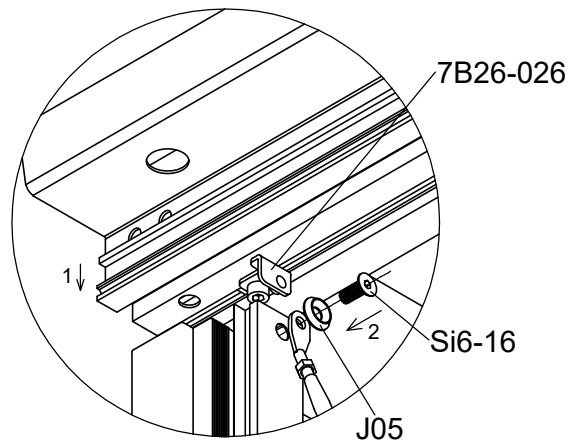
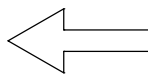
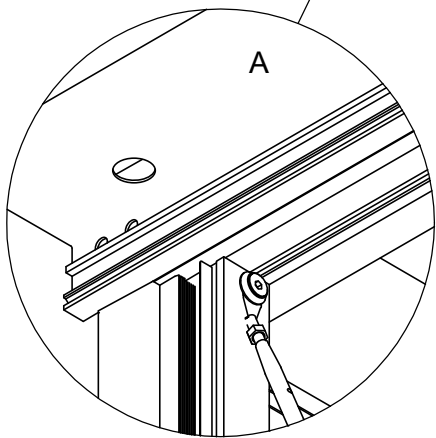

Front
Framsida
Forside
Framsida
Etupuoli



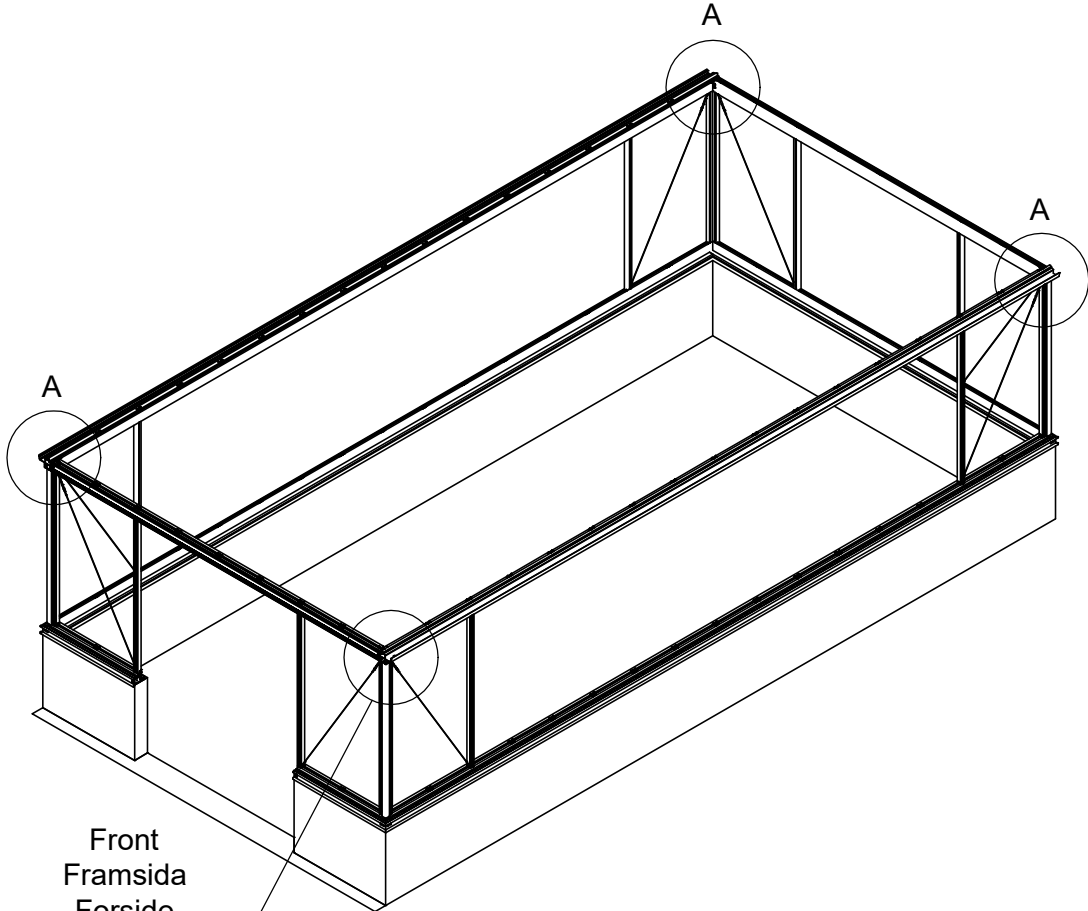

Part	NO.	QTY.	Length(MM)
	7B26-029	4	PCS
	M6-20	8	PCS

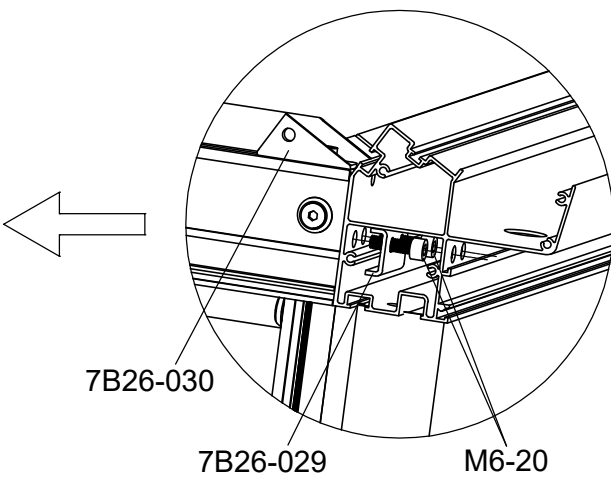
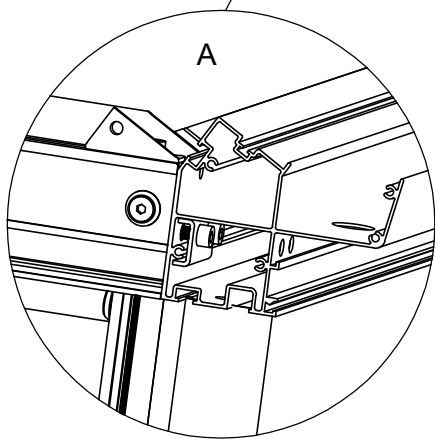

Front
 Framsida
 Forside
 Framside
 Etupuoli



Part	NO.	QTY.	Length(MM)
	40A-Y30	8	1235
	Si6-16	14	PCS
	J05	14	PCS

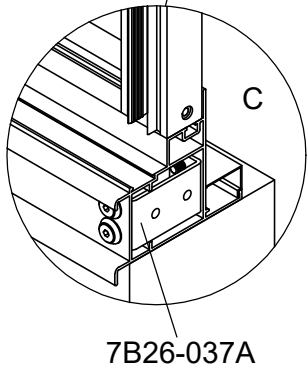
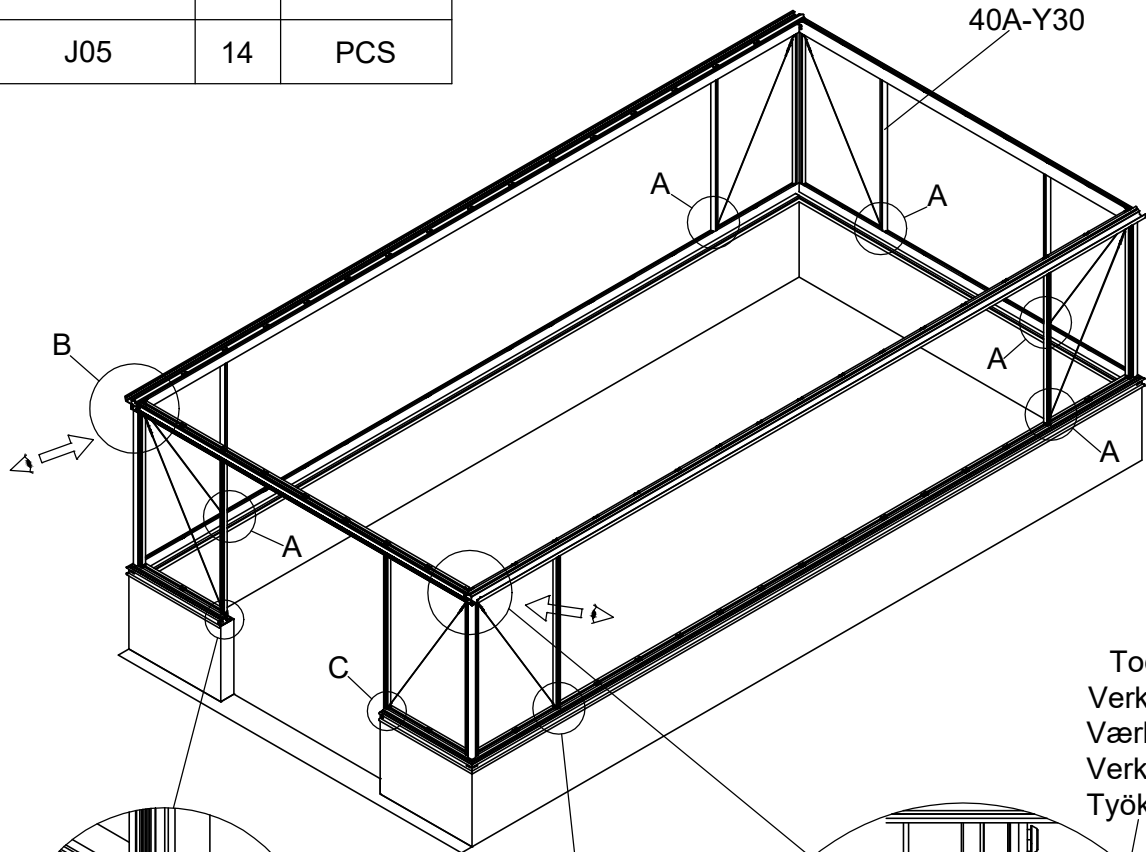

7B26-037A

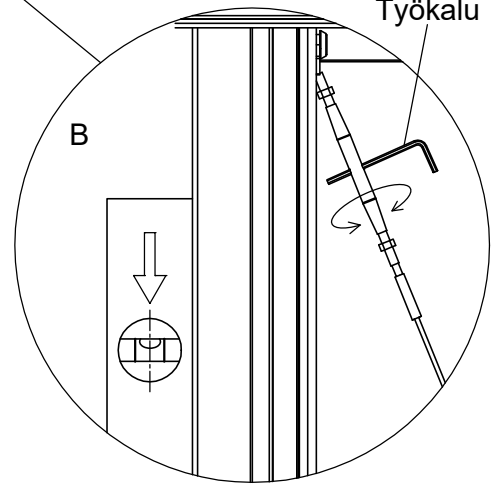

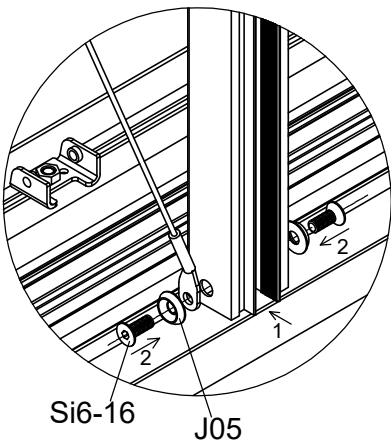

Tool
Verktøj
Værktøj
Verktøy
Työkalu



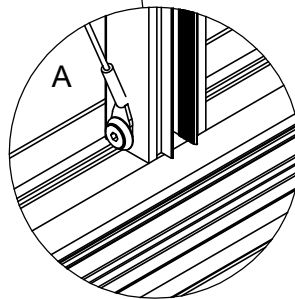

Si6-16
J05



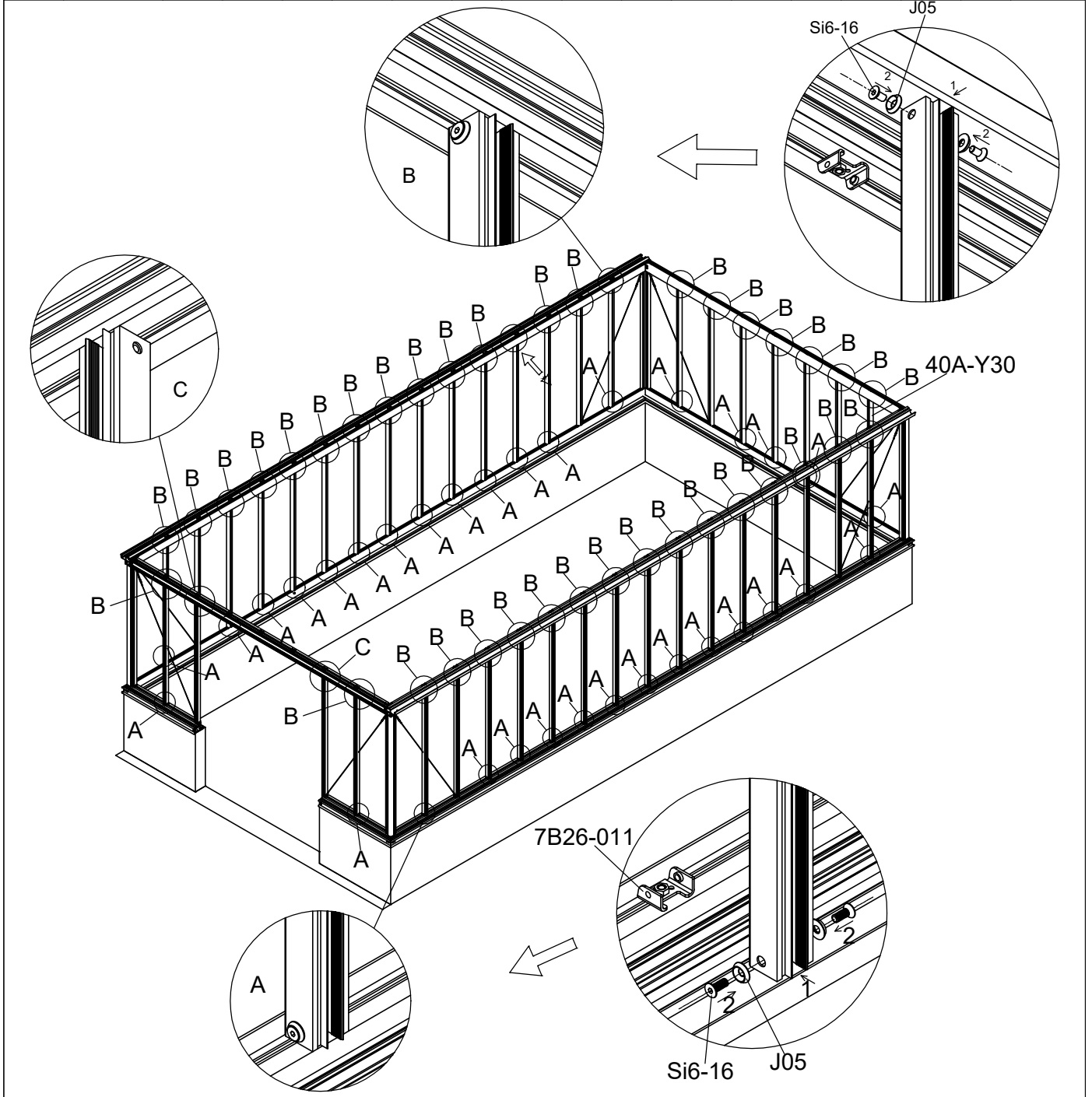

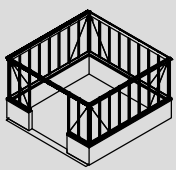
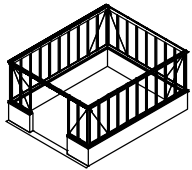
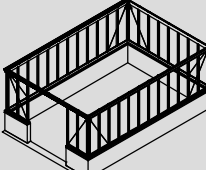
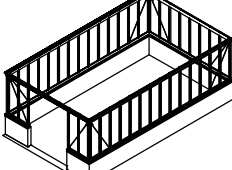
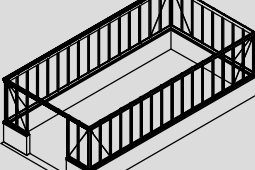



Part	NO.	QTY.															Length (MM)
		3051			3052			3053			3058			3059			
		3051	3140P-S	3140P-S-2	3052	3140P-S	3140P-S-2	3053	3140P-S	3140P-S-2	3058	3140P-S	3140P-S-2	3059	3140P-S	3140P-S-2	
	40A-Y30	3	14	0	5	14	2	7	14	4	9	14	6	11	14	8	1235
	Si6-16	26	56	0	34	56	8	42	56	16	50	56	24	58	56	32	PCS
	J05	26	56	0	34	56	8	42	56	16	50	56	24	58	56	32	PCS





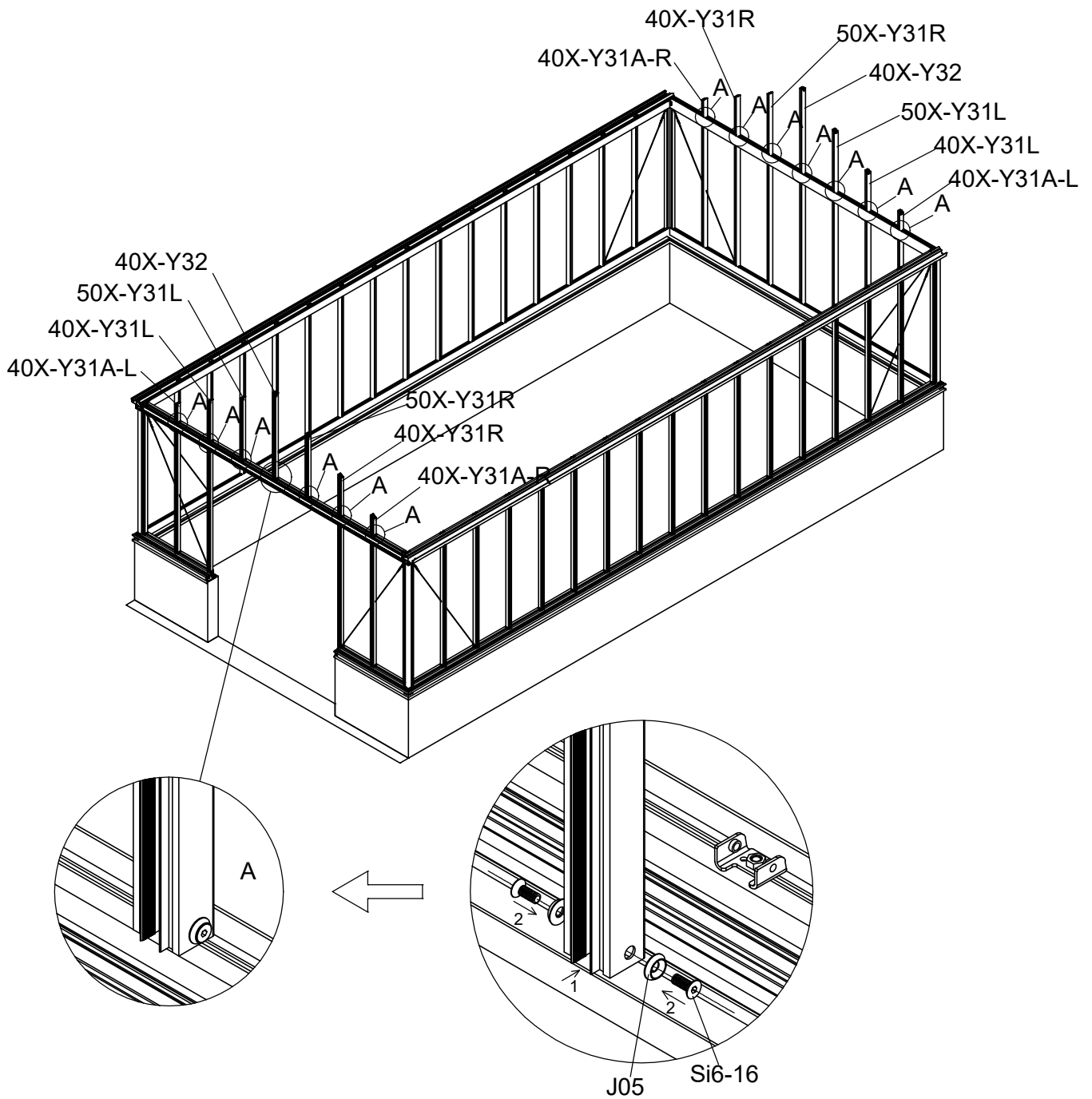

3051	3052	3053	3058	3059
				

Part	NO.	QTY.	Length(MM)
	40X-Y31R	2	418
	40X-Y31L	2	418
	40X-Y32	2	859
	Si6-16	12	PCS
	J05	12	PCS

Part	NO.	QTY.	Length(MM)	CTN NO.
	40X-Y31A-R	2	201	3140P-S
	40X-Y31A-L	2	201	3140P-S
	50X-Y31R	2	633	3140P-S
	50X-Y31L	2	633	3140P-S
	Si6-16	16	PCS	3140P-S
	J05	16	PCS	3140P-S





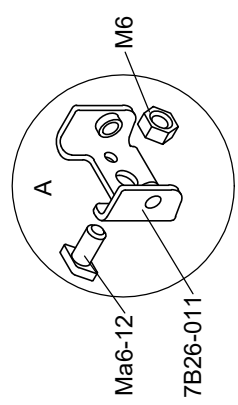
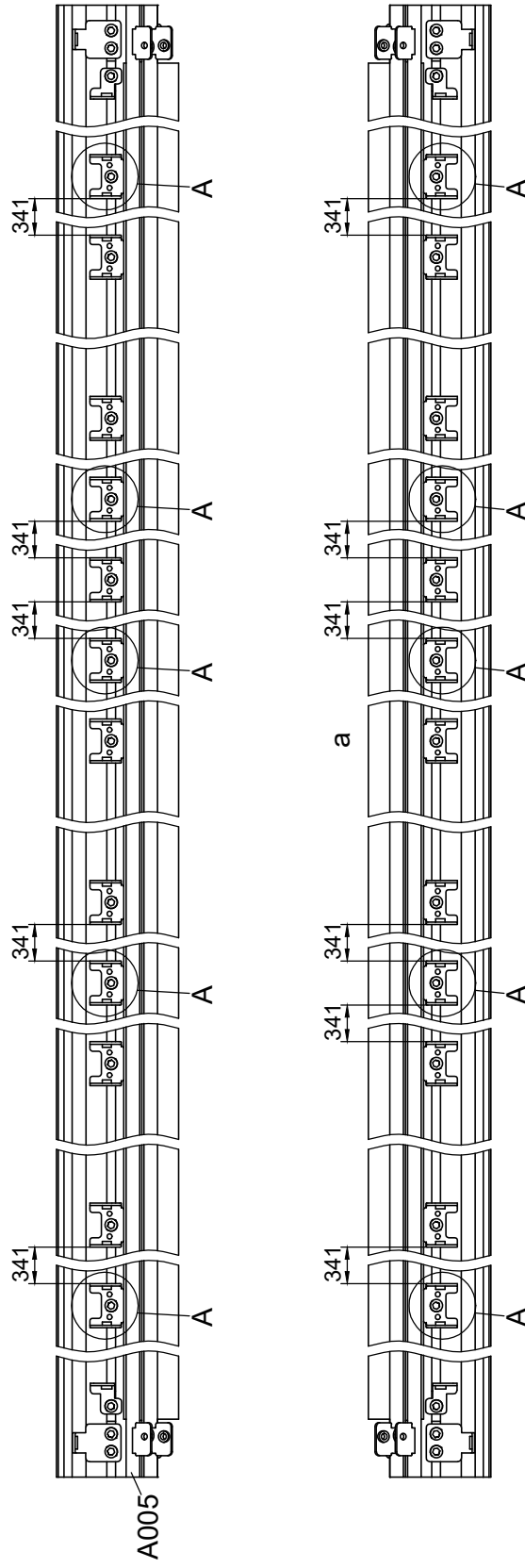



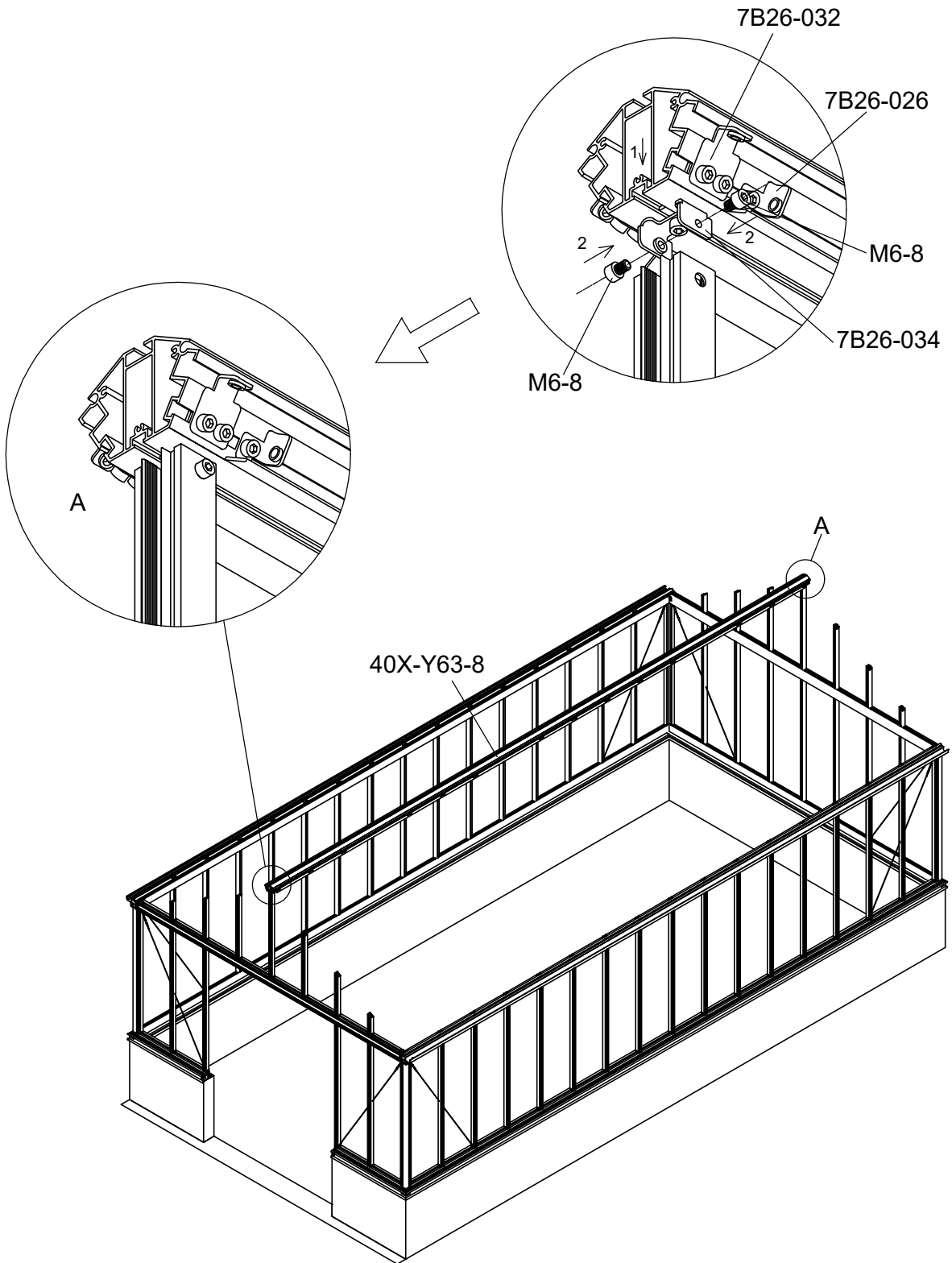

Part	Product	NO.	Length (MM)	QTY.	Code	QTY.						Length (MM)								
						Part	NO.	3051	3052	3053	3058		3059							
	3051	40X-Y63-4	3118	1	A005		3140P-S-2	6	0	6	2	6	2	6	4	PCS				
	3052	40X-Y63-5	3869			7B26-011	NO.	3140P-S-2	6	0	6	2	6	2	6	4	PCS			
	3053	40X-Y63-6	4620			M6	M6		Ma6-12	6	0	6	2	6	2	6	4	PCS		
	3058	40X-Y63-7	5371								M6	6	0	6	2	6	2	6	4	PCS
	3059	40X-Y63-8	6122									6	0	6	2	6	2	6	4	PCS









Part	NO.	QTY.	Length(MM)
	M6-8	4	PCS

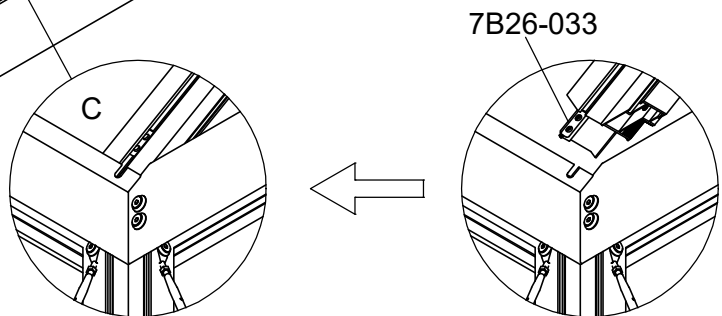
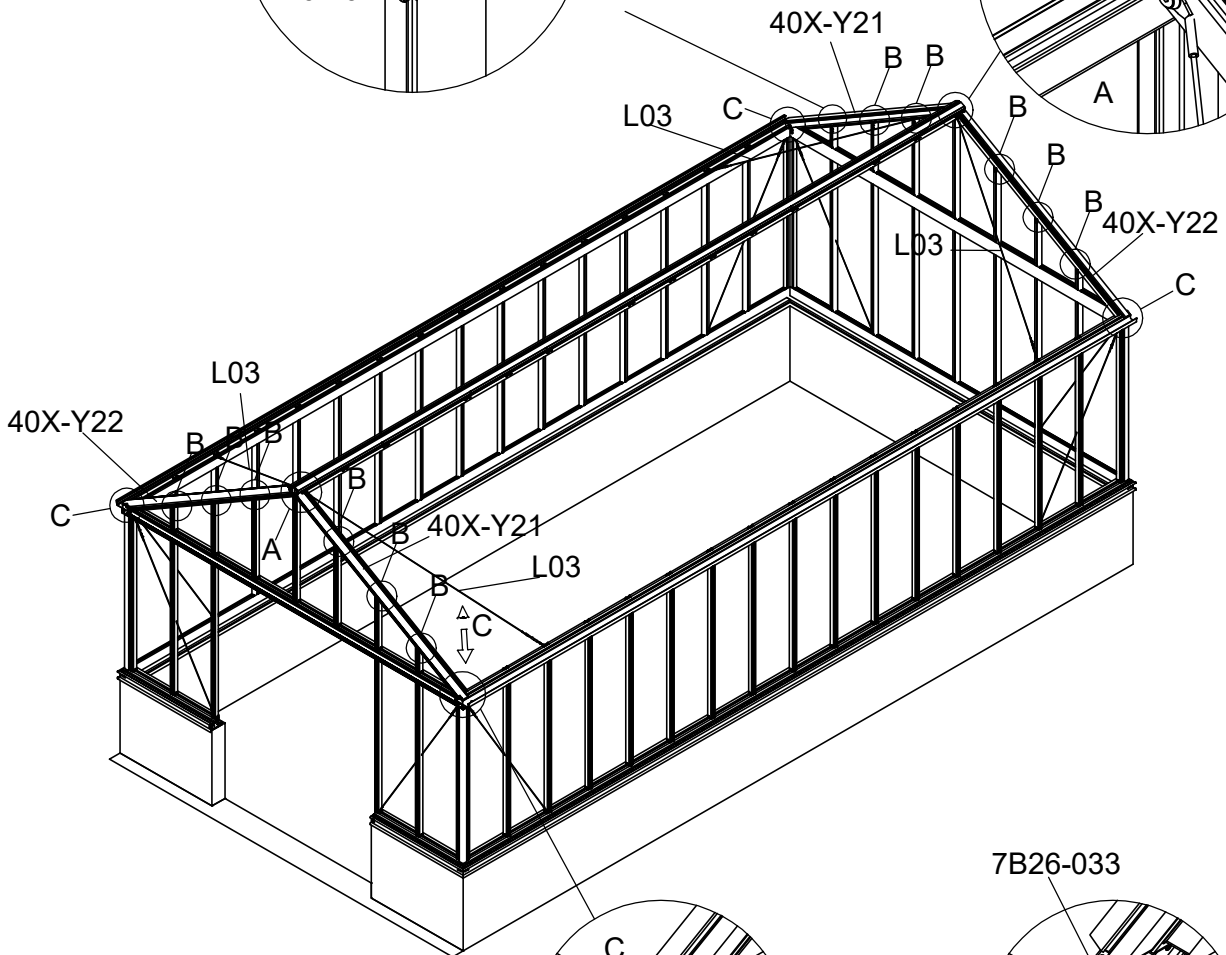
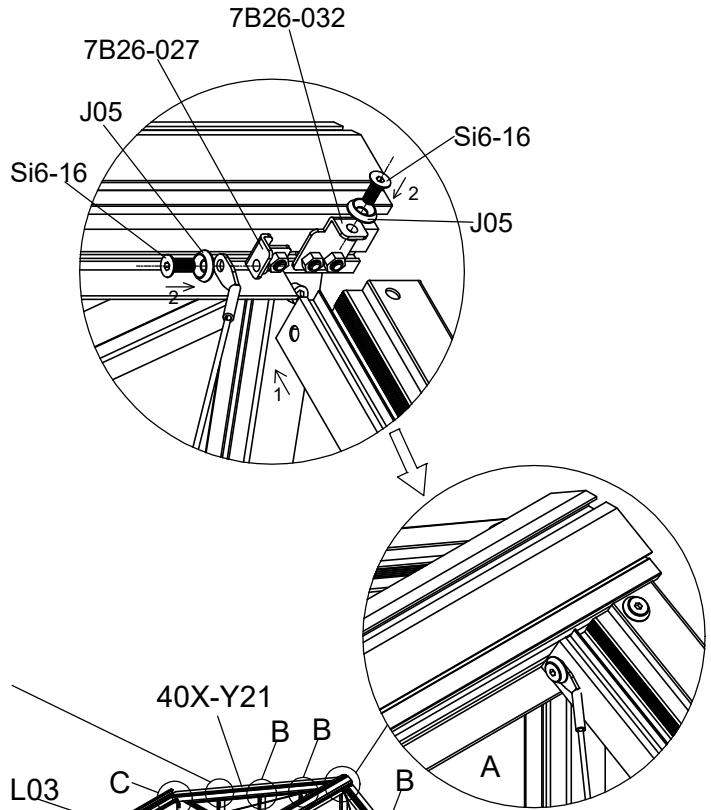



Part	NO.	QTY.	Length(MM)
	40X-Y21	2	1755
	40X-Y22	2	1755
	Si6-16	8	PCS
	J05	8	PCS
	L03	4	1830
	S6-10	16	PCS
	7B26-033	4	PCS







Part	NO.	QTY.	Length(MM)	CTN NO.
	S6-10	32	PCS	3140P-S

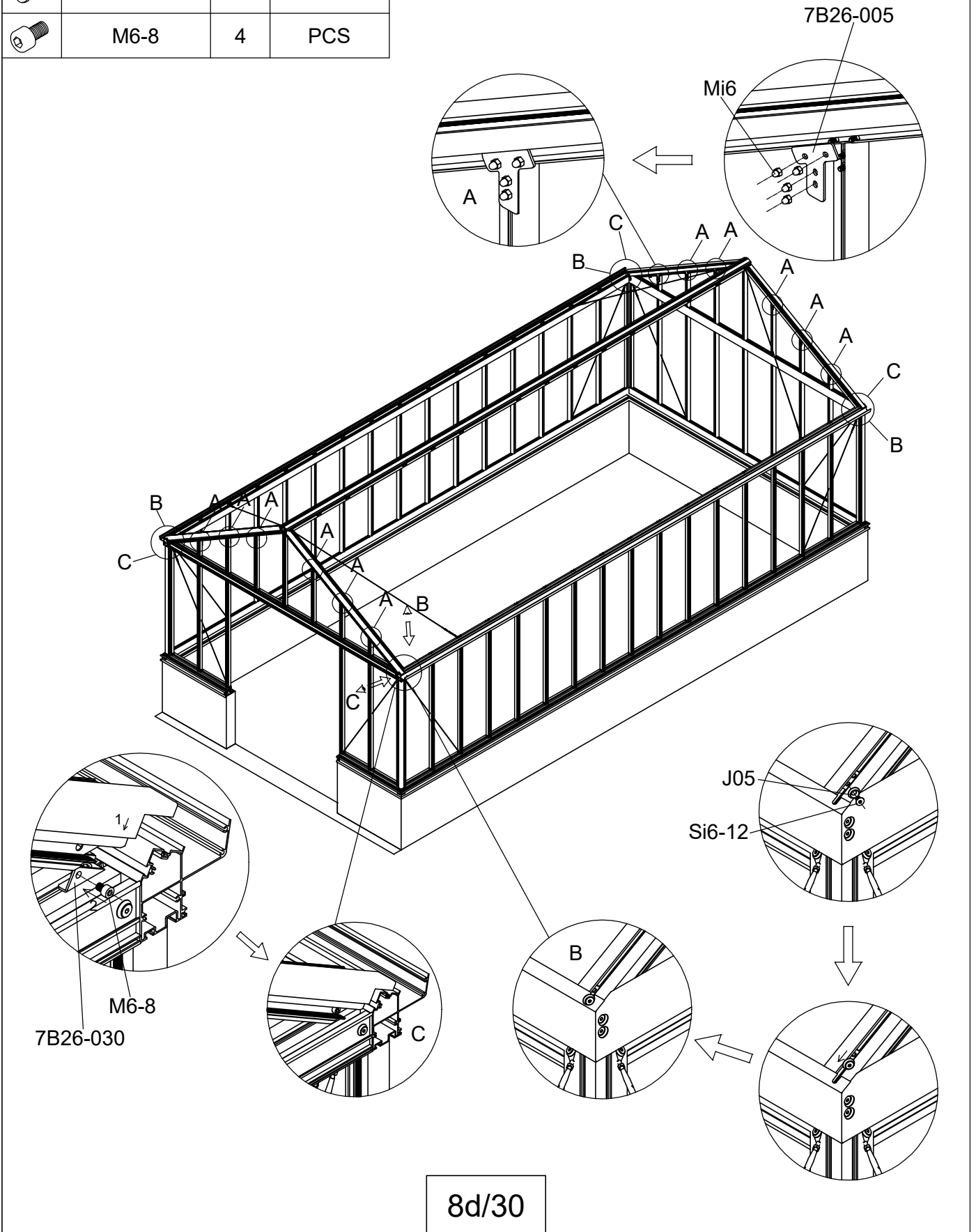



Part	NO.	QTY.	Length(MM)
	7B26-005	4	PCS
	Mi6	16	PCS
	J05	4	PCS
	Si6-12	4	PCS
	M6-8	4	PCS

Part	NO.	QTY.	Length(MM)	CTN NO.
	7B26-005	8	PCS	3140P-S
	Mi6	32	PCS	3140P-S

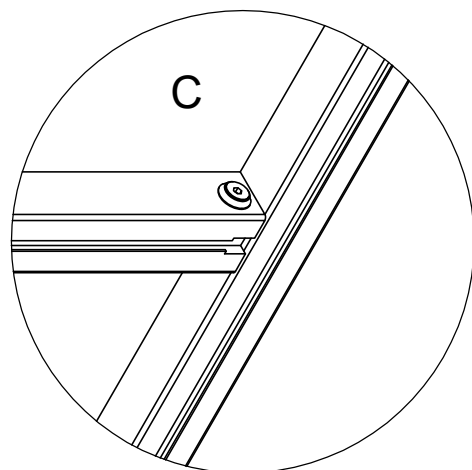
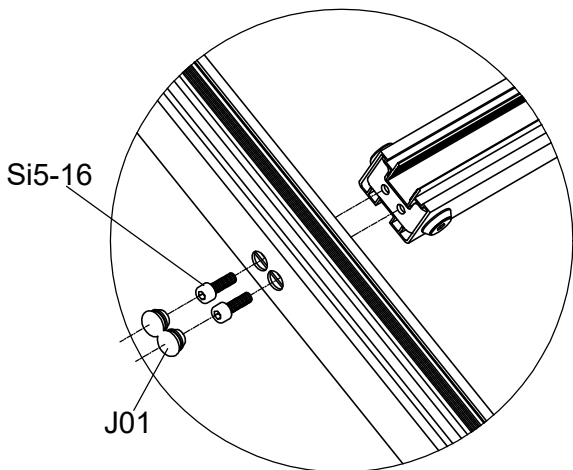
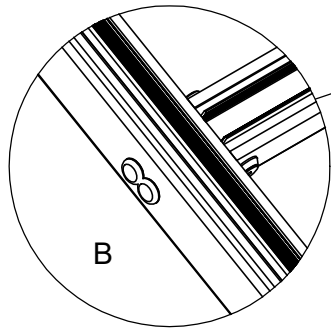
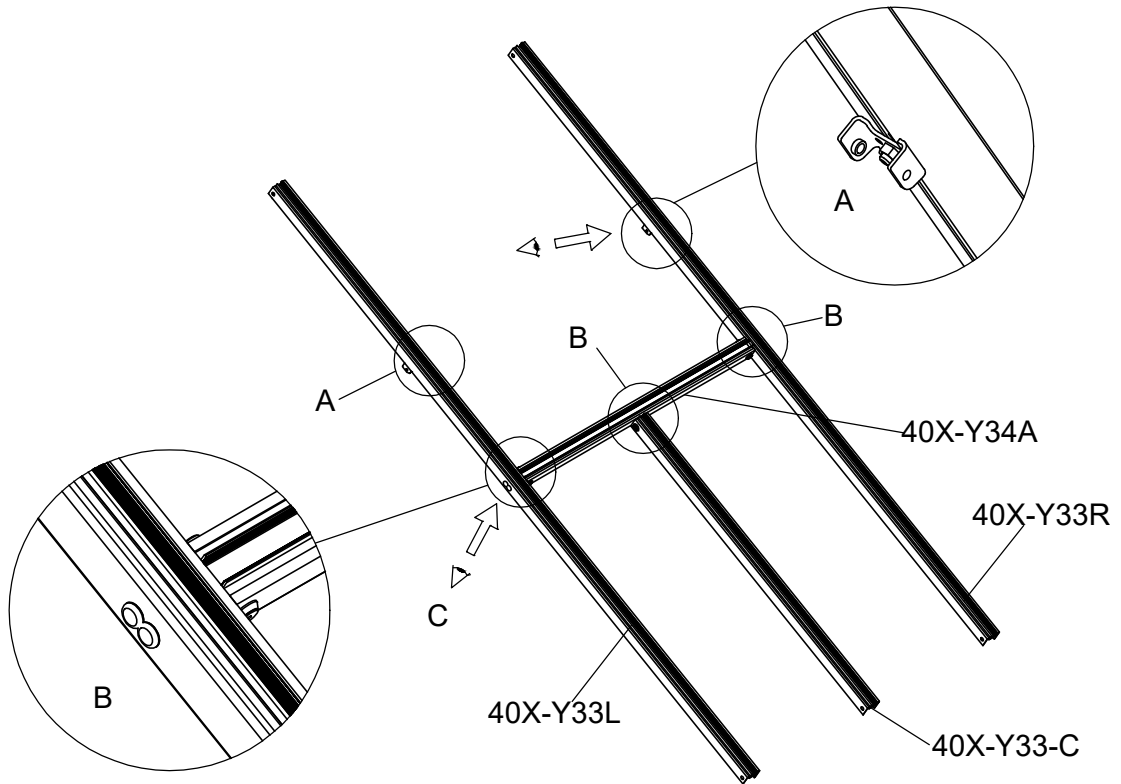

Part	NO.	QTY.															Length (MM)
		3051			3052			3053			3058			3059			
		3051	3140P-S	3140P-S-2	3052	3140P-S	3140P-S-2	3053	3140P-S	3140P-S-2	3058	3140P-S	3140P-S-2	3059	3140P-S	3140P-S-2	
	40X-Y33R	2	0	0	4	0	0	4	0	0	6	0	0	6	0	0	1716
	40X-Y33L	2	0	0	4	0	0	4	0	0	6	0	0	6	0	0	1716
	Si5-16	8	4	0	16	4	4	16	4	4	24	4	8	24	4	8	PCS
	J01	8	4	0	16	4	4	16	4	4	24	4	8	24	4	8	PCS
	40X-Y34A	0	2	0	0	2	2	0	2	2	0	2	4	0	2	4	713
	40X-Y33-C	0	2	0	0	2	2	0	2	2	0	2	4	0	2	4	839





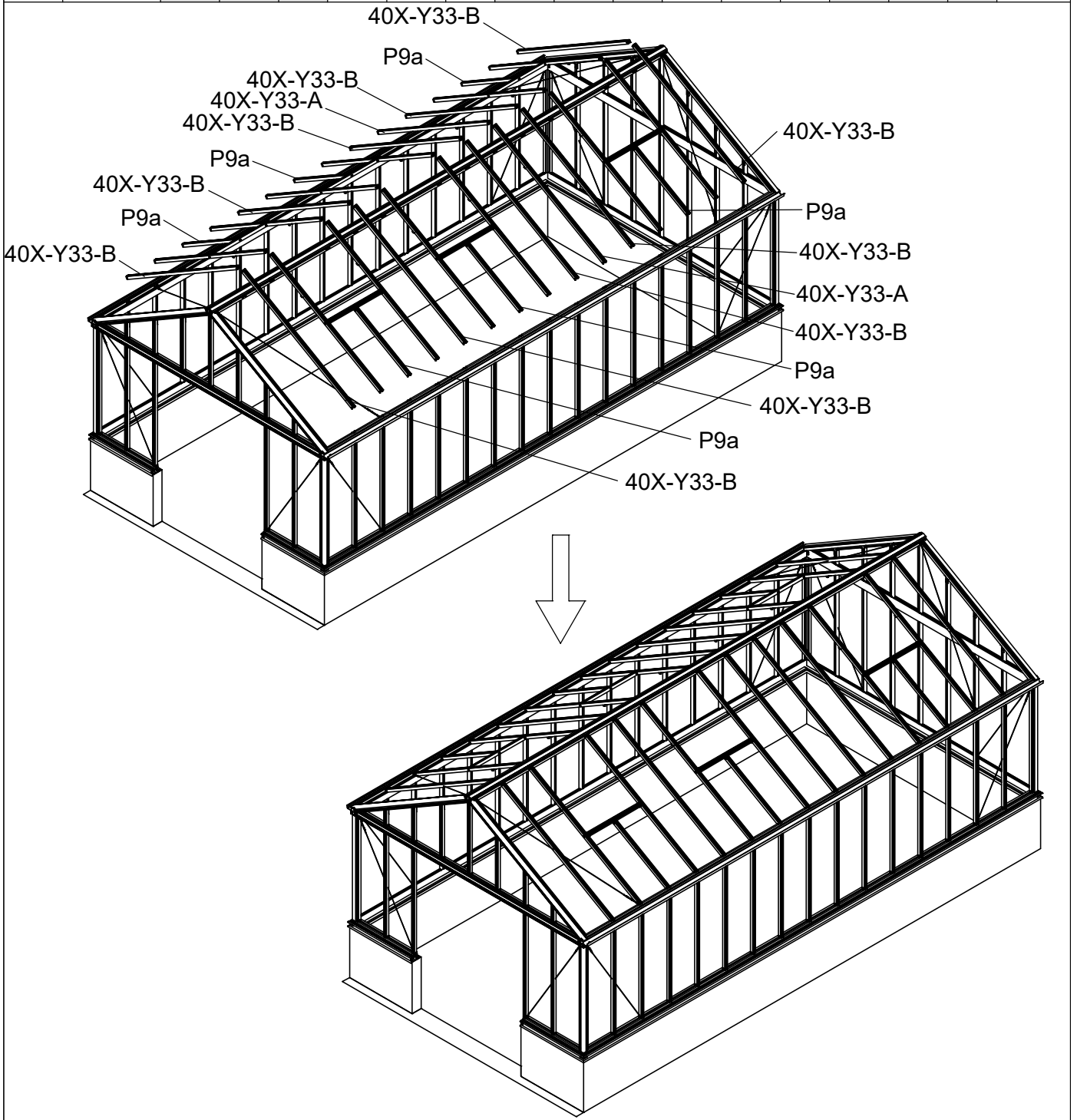

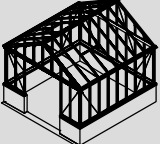
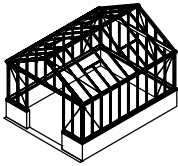
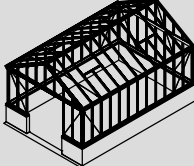
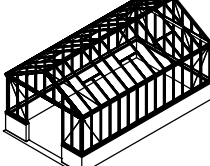
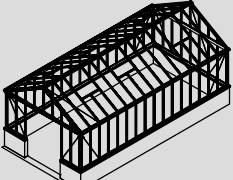
Part	NO.	QTY.														Length (MM)	
		3051			3052			3053			3058			3059			
		3051	3140P-S	3140P-S-2	3052	3140P-S	3140P-S-2	3053	3140P-S	3140P-S-2	3058	3140P-S	3140P-S-2	3059	3140P-S		3140P-S-2
	40X-Y33-A	2	0	0	0	0	0	2	0	0	0	0	0	2	0	0	1716
	40X-Y33-B	0	6	0	0	6	0	0	6	2	0	6	2	0	6	4	1716

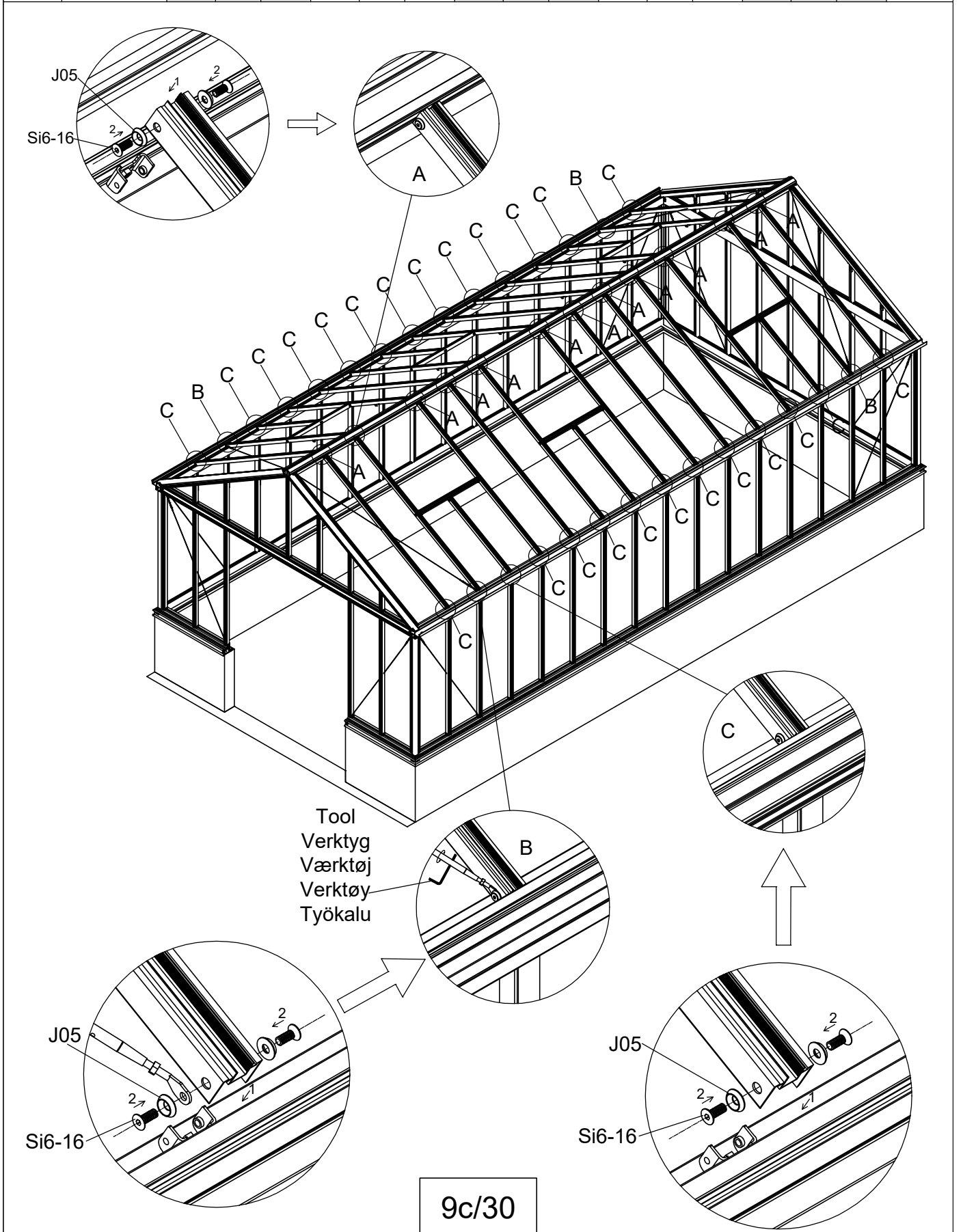

3051	3052	3053	3058	3059
				

Part	NO.	QTY.															Length (MM)
		3051			3052			3053			3058			3059			
		3051	3140P-S	3140P-S-2	3052	3140P-S	3140P-S-2	3053	3140P-S	3140P-S-2	3058	3140P-S	3140P-S-2	3059	3140P-S	3140P-S-2	
⊕	Si6-16	24	28	0	32	28	4	40	28	12	48	28	16	56	28	24	PCS
⊙	J05	24	28	0	32	28	4	40	28	12	48	28	16	56	28	24	PCS



Part	NO.	QTY.					Length(MM)
		3051	3052	3053	3058	3059	
	40X-Y35	3	4	5	6	7	1500
	Si6-16	12	16	20	24	28	PCS
	J05	12	16	20	24	28	PCS

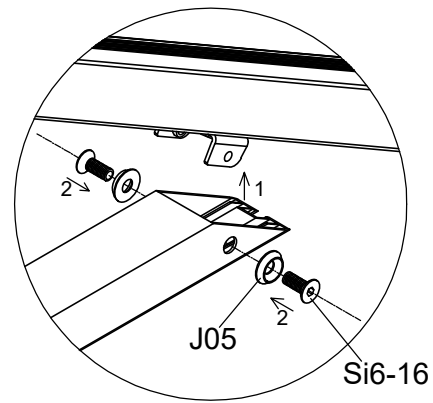
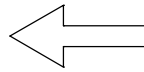
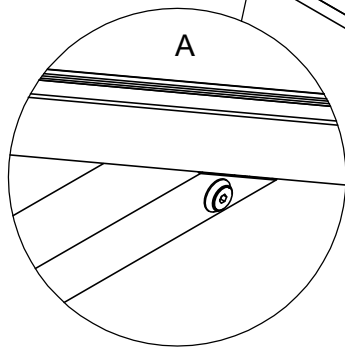
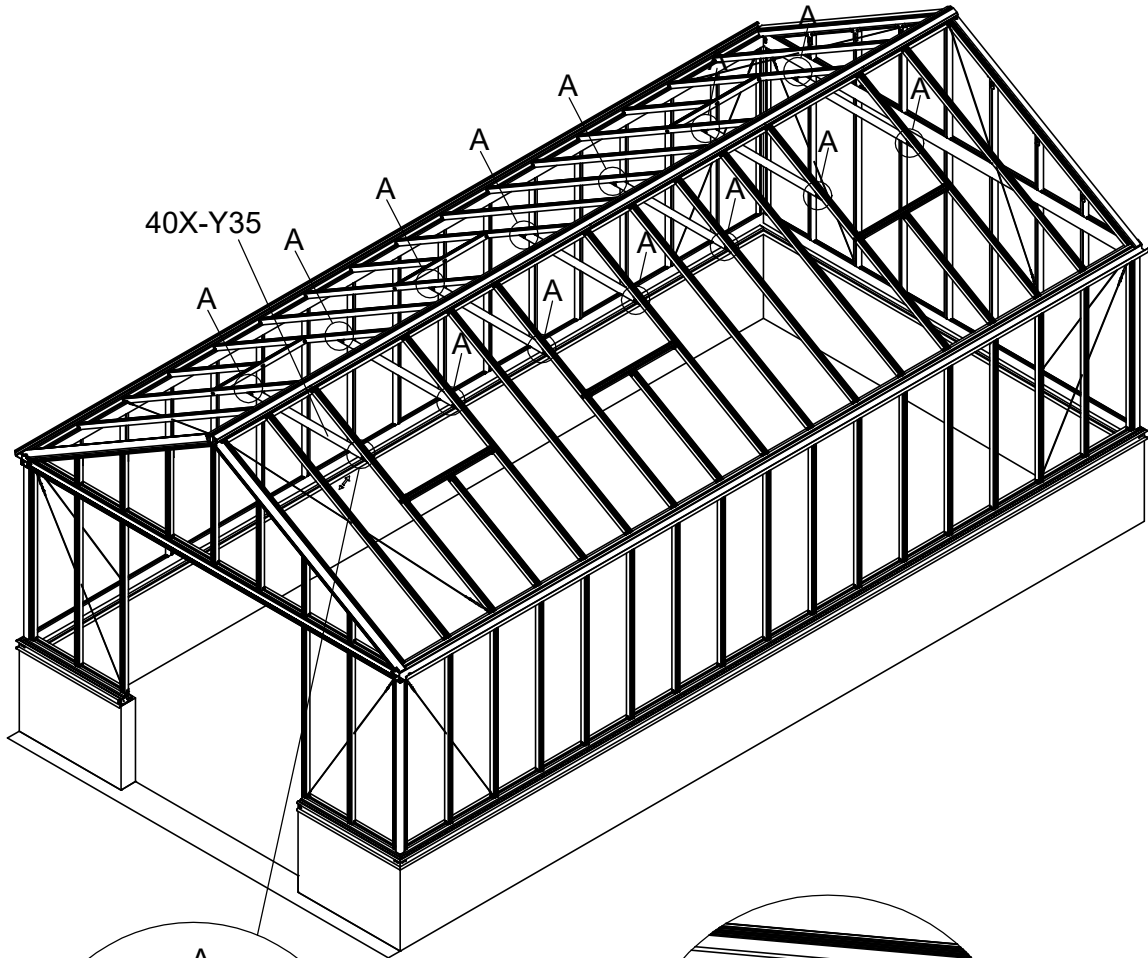

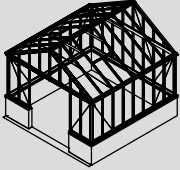
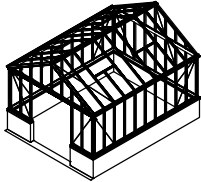
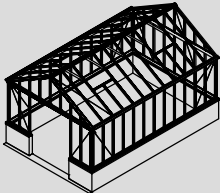
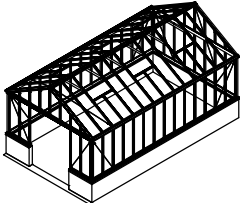
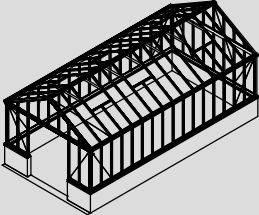
3051	3052	3053	3058	3059
				

Part	NO.	QTY.					Length(MM)
		3051	3052	3053	3058	3059	
	354×1262	12	14	16	18	20	1262

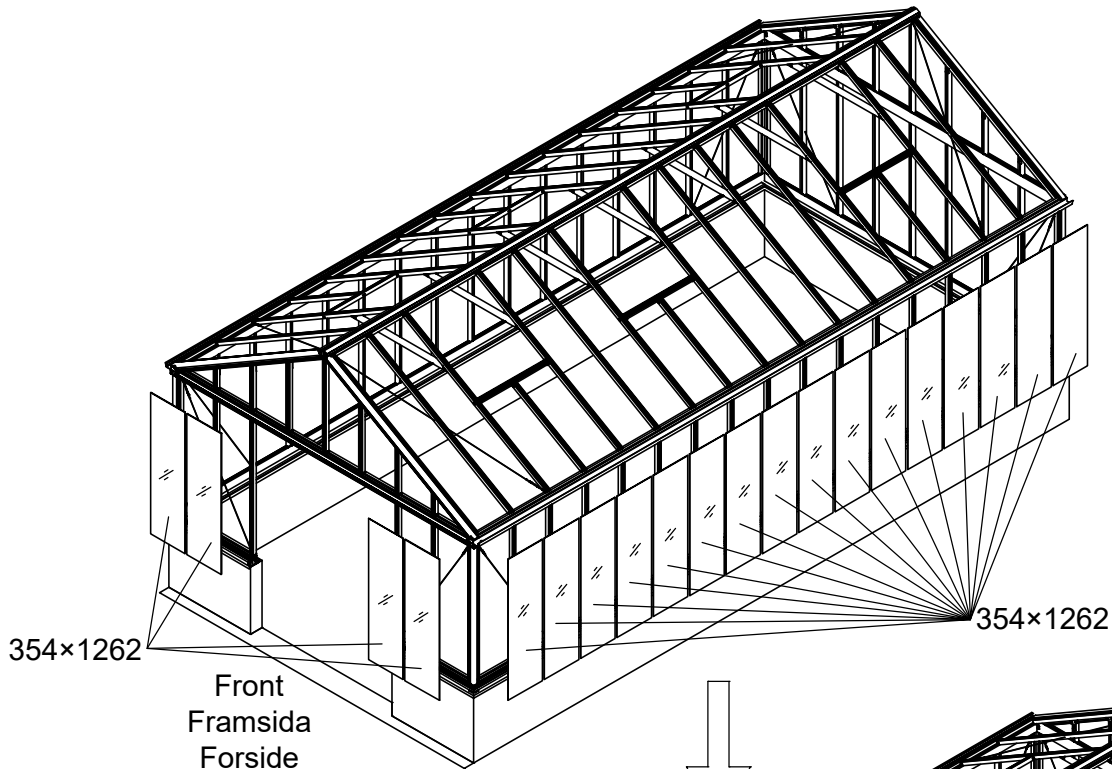

Front
Fransida
Forside
Franside
Etupuoli

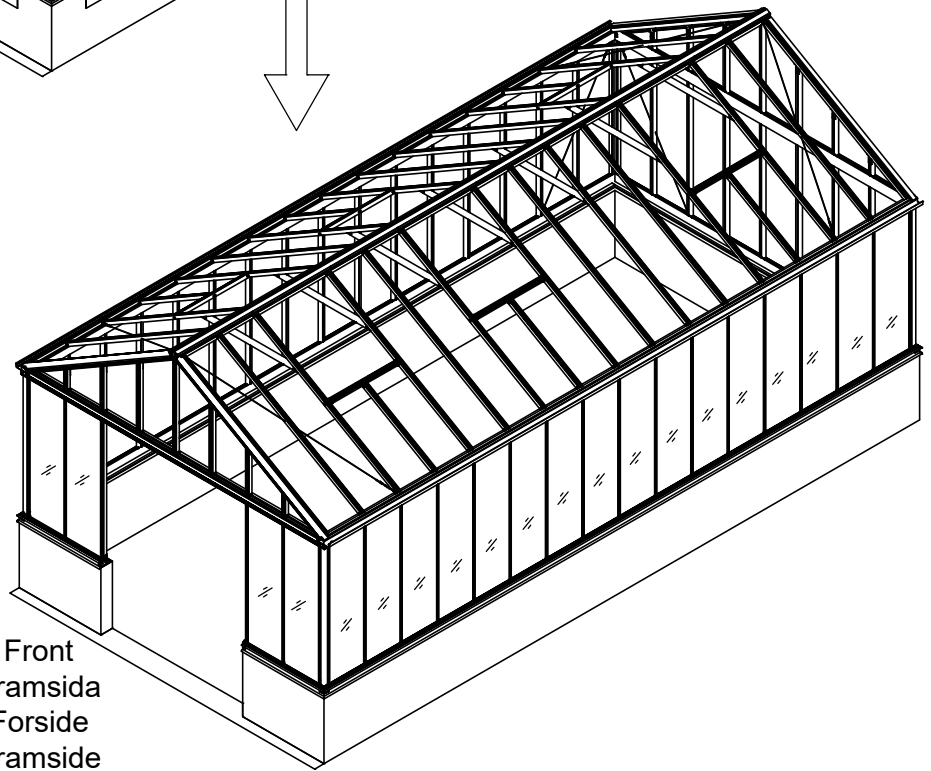
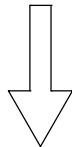

Front
Fransida
Forside
Franside
Etupuoli



3051	3052	3053	3058	3059

10a/30

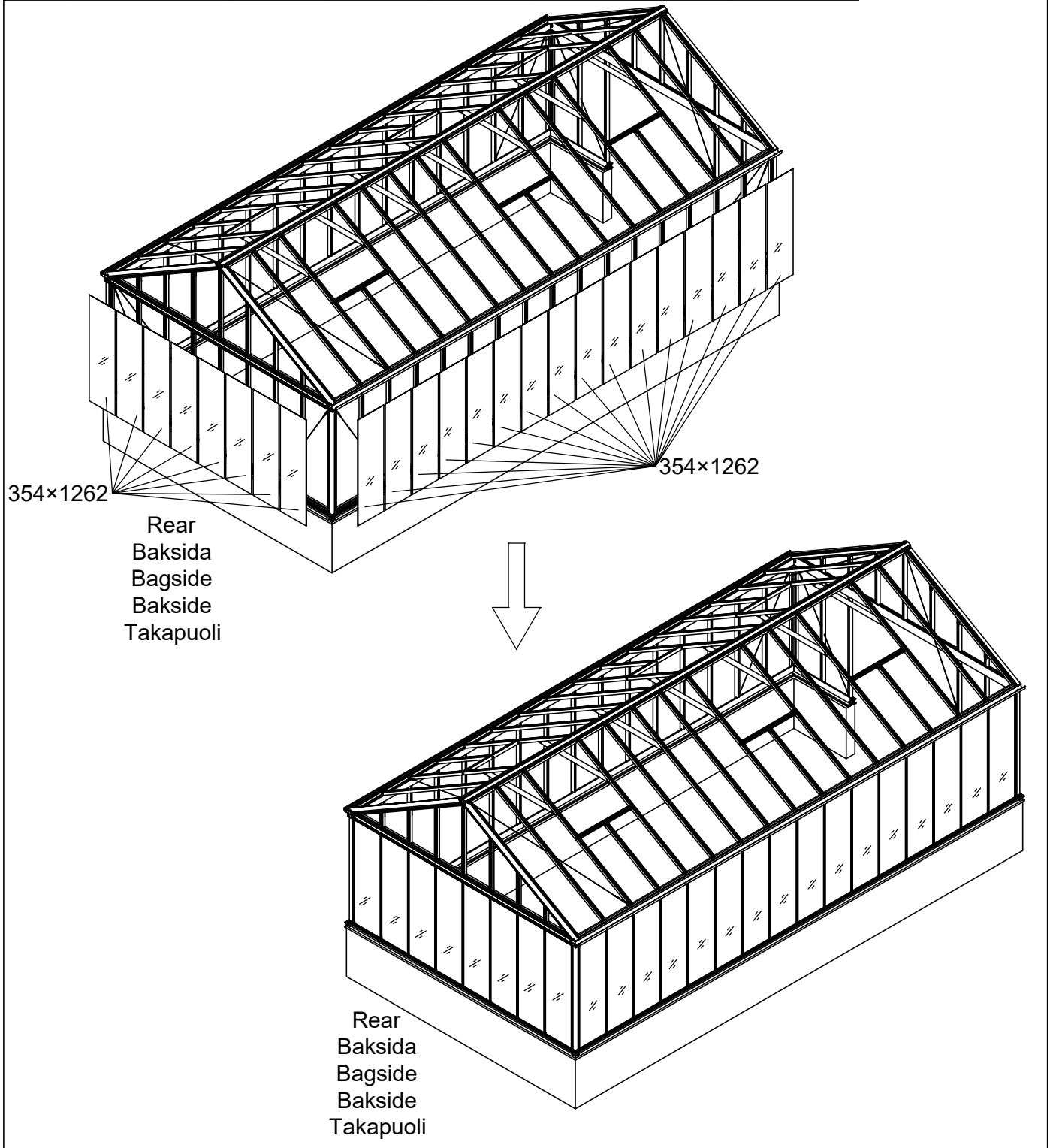
Part	NO.	QTY.					Length(MM)
		3051	3052	3053	3058	3059	
	354×1262	16	18	20	22	24	1262



3051	3052	3053	3058	3059

Part	NO.	QTY.	Length(MM)
	40X-Y14	1	3149
	40A-Y15-R	1	842
	40A-Y15-L	1	842

Part	Product	NO.	Length (MM)	QTY.	Code
	3051	40X-Y15-4	3149	2	A006
	3052	40X-Y15-5	3900		
	3053	40X-Y15-6	4651		
	3058	40X-Y15-7	5402		
	3059	40X-Y15-8	6153		

Tool
Verktøj
Værktøj
Verktøy
Työkalu

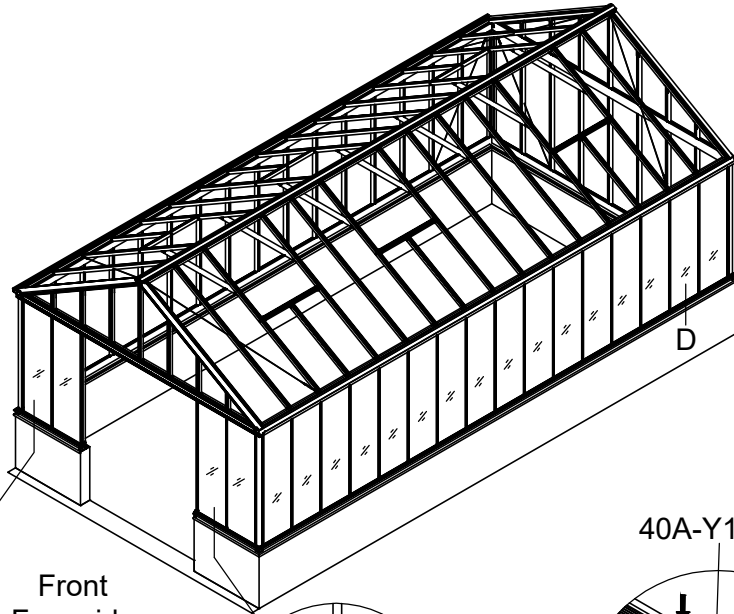
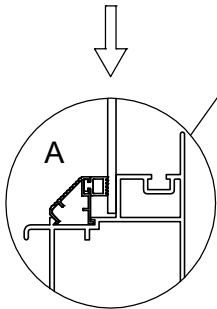
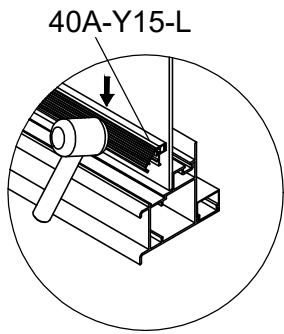

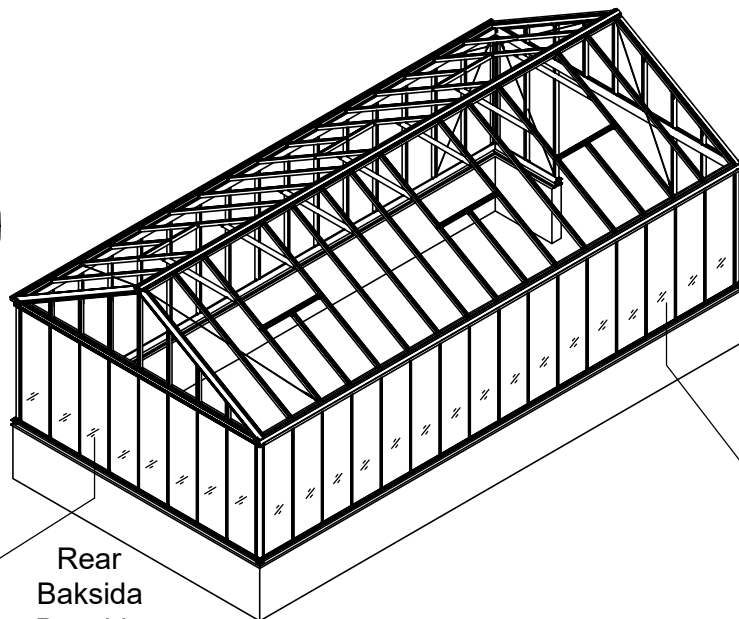
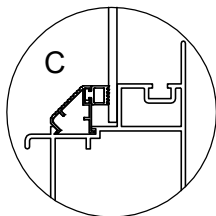
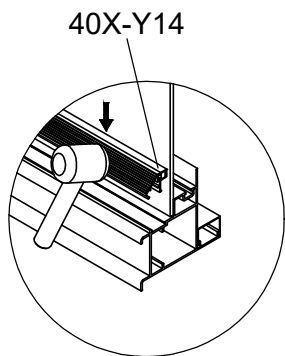
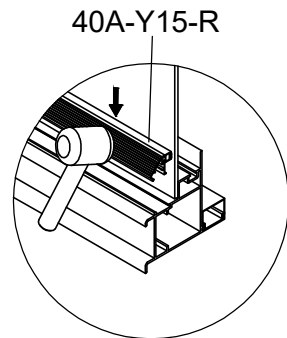
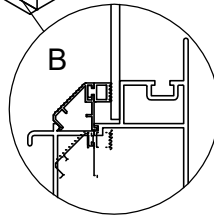

Front
Framsida
Forside
Framsida
Etupuoli

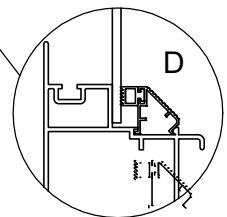
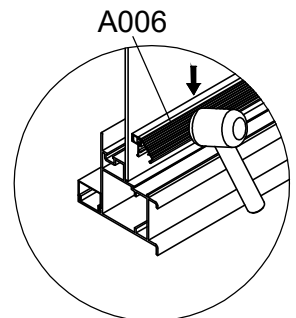

Rear
Baksida
Bagside
Baksida
Takapuoli



Part	NO.	QTY.															Length (MM)
		3051			3052			3053			3058			3059			
		3051	3140P-S	3140P-S-2	3052	3140P-S	3140P-S-2	3053	3140P-S	3140P-S-2	3058	3140P-S	3140P-S-2	3059	3140P-S	3140P-S-2	
	40A-Y01	8	6	0	9	6	1	10	6	2	11	6	3	12	6	4	1235
	40A-Y02	1	0	0	1	0	0	1	0	0	1	0	0	1	0	0	1235

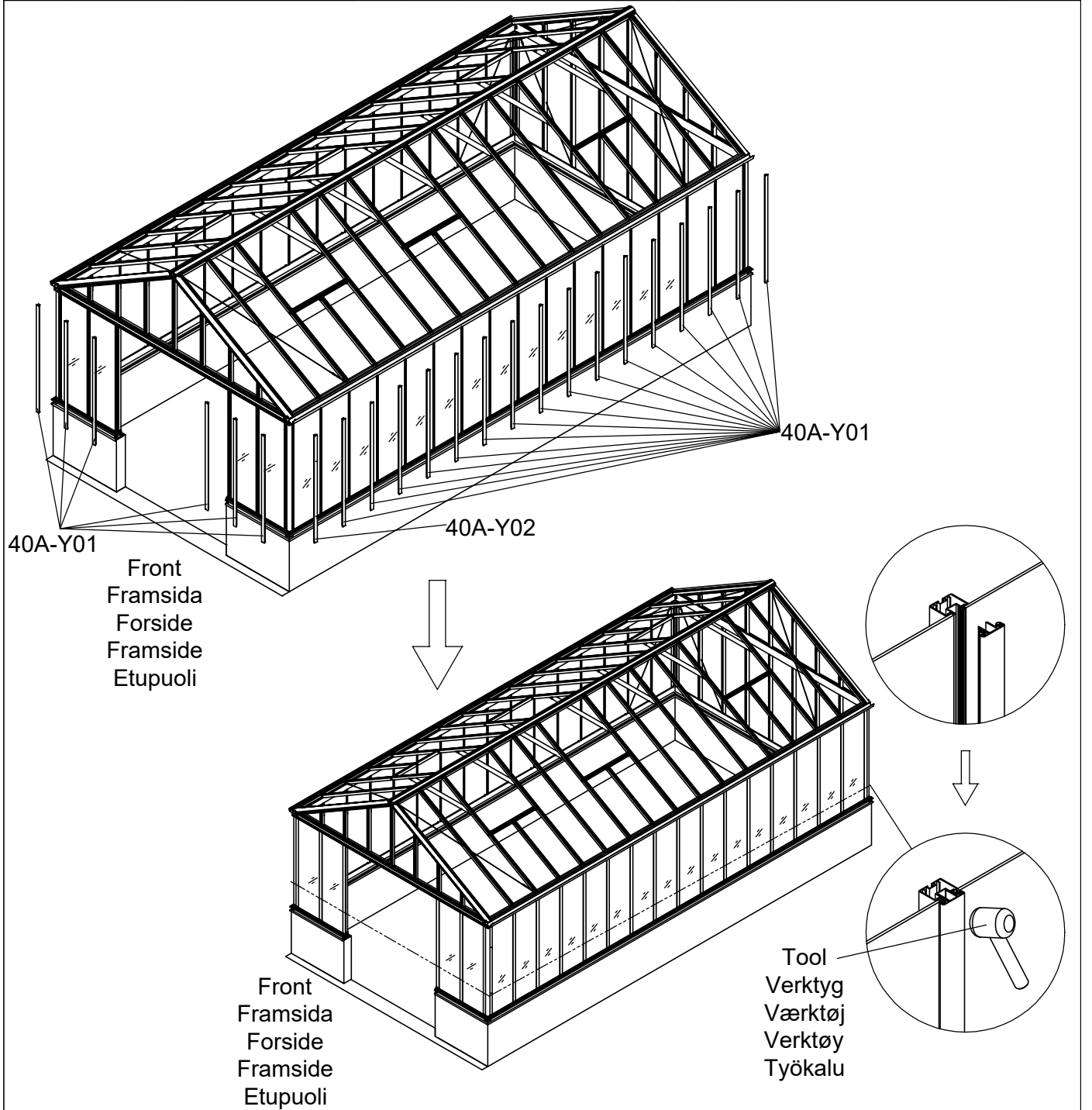

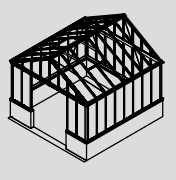
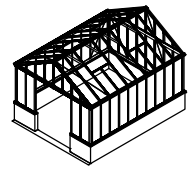
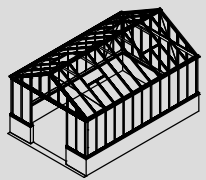
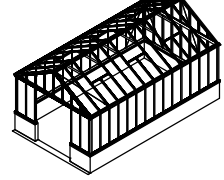
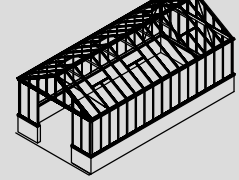
3051	3052	3053	3058	3059
				

Part	NO.	QTY.															Length (MM)
		3051			3052			3053			3058			3059			
		3051	3140P-S	3140P-S-2	3052	3140P-S	3140P-S-2	3053	3140P-S	3140P-S-2	3058	3140P-S	3140P-S-2	3059	3140P-S	3140P-S-2	
	40A-Y01	9	8	0	10	8	1	11	8	2	12	8	3	13	8	4	1235
	40A-Y02	1	0	0	1	0	0	1	0	0	1	0	0	1	0	0	1235

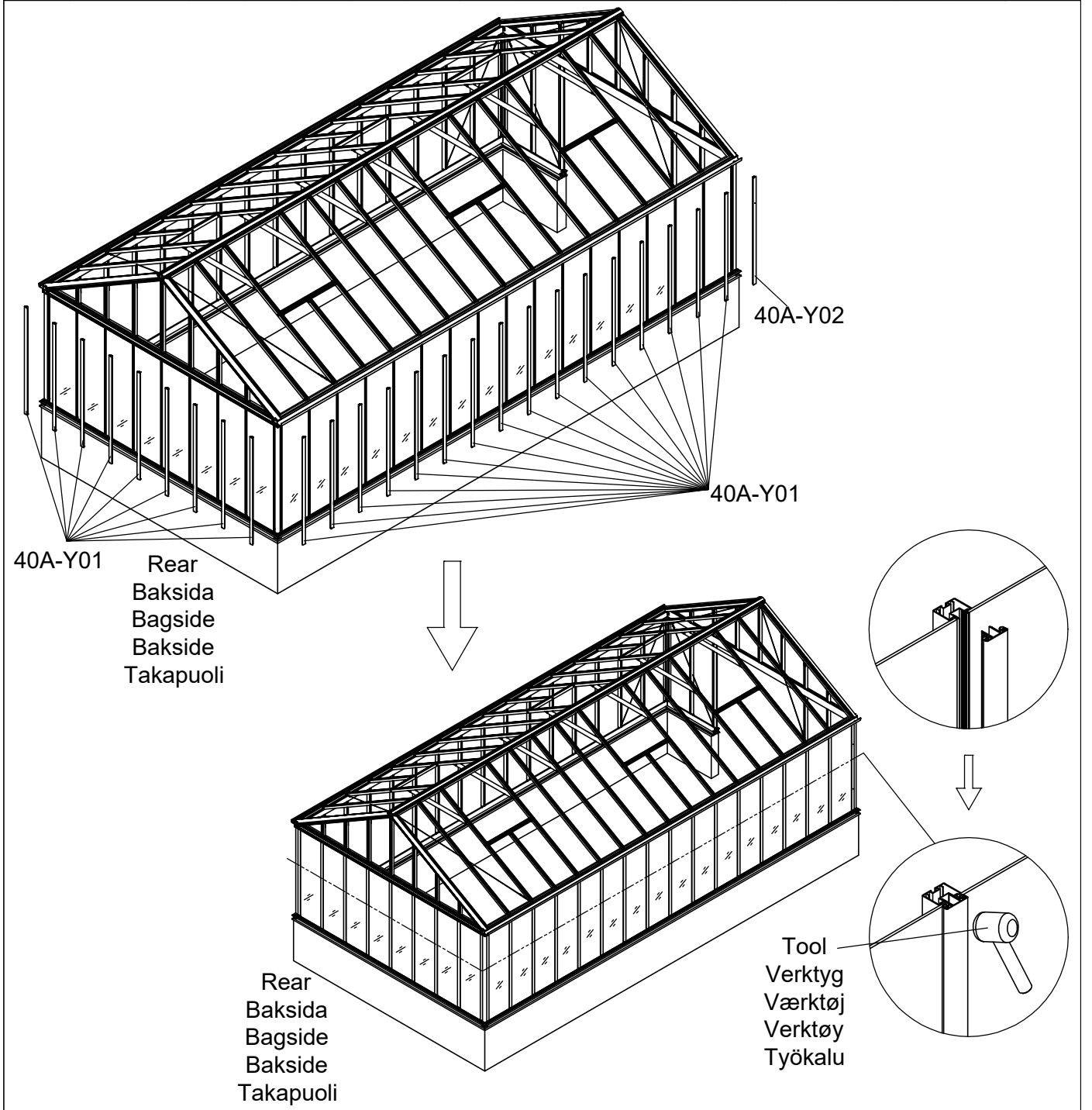

3051	3052	3053	3058	3059

Part	NO.	QTY.					Length(MM)
		3051	3052	3053	3058	3059	
	7C26-007N	11.5M	13M	14.5M	16M	17.5M	

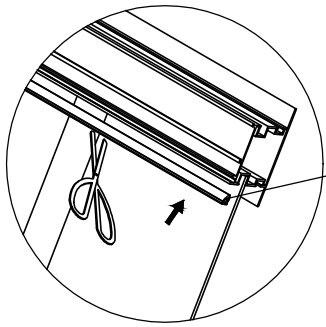

7C26-007N

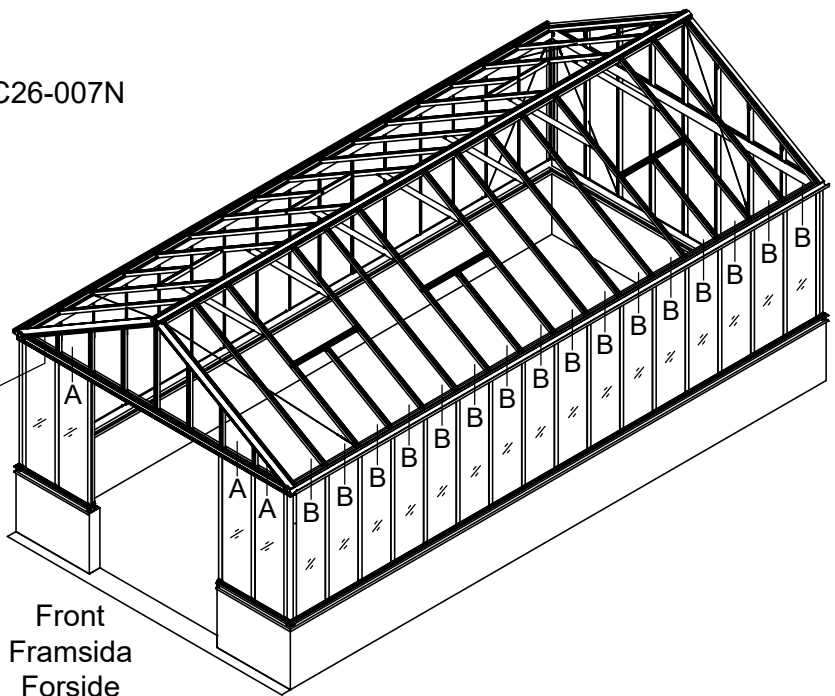
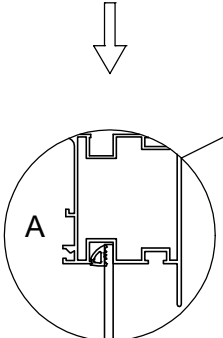



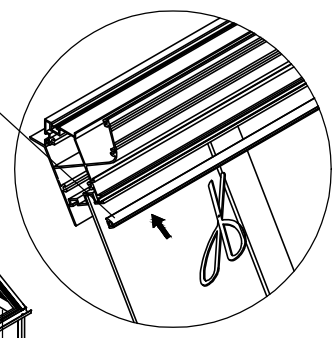

Front
Framsida
Forside
Framsida
Etupuoli

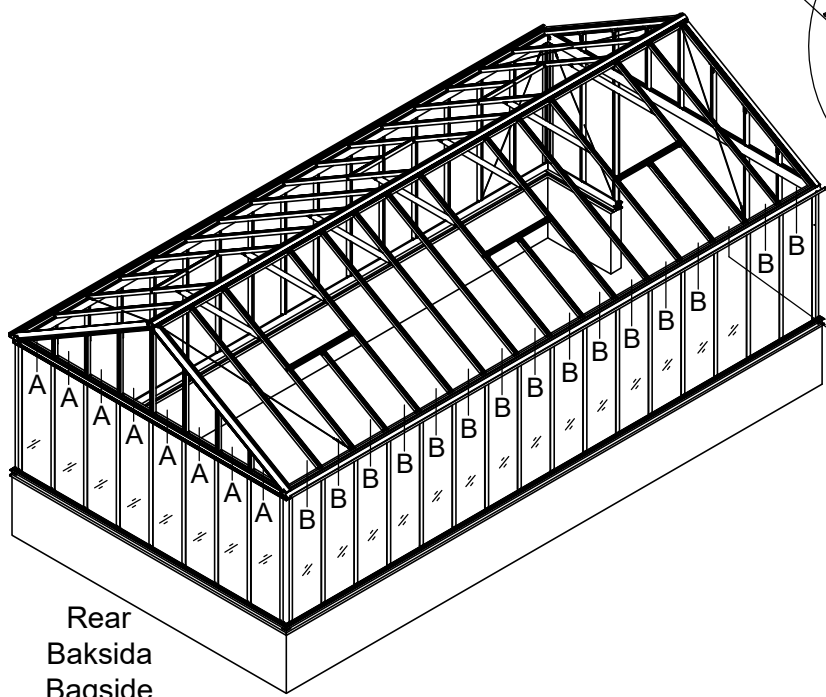
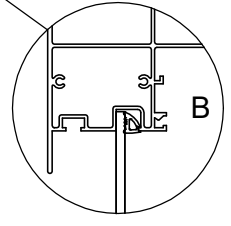

7C26-007N



Rear
Baksida
Bagside
Baksida
Takapuoli

Part	NO.	QTY.	Length(MM)
	324×203	2	324
	354×420	2	420
	354×635	2	635
	354×852	2	852

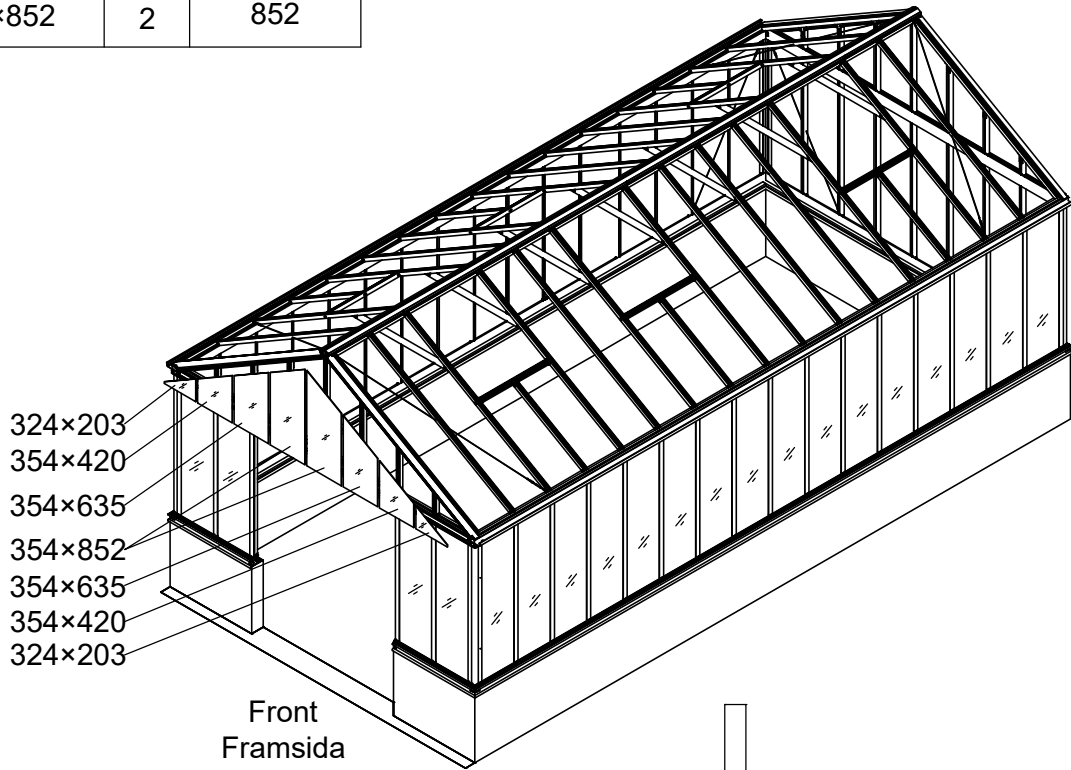



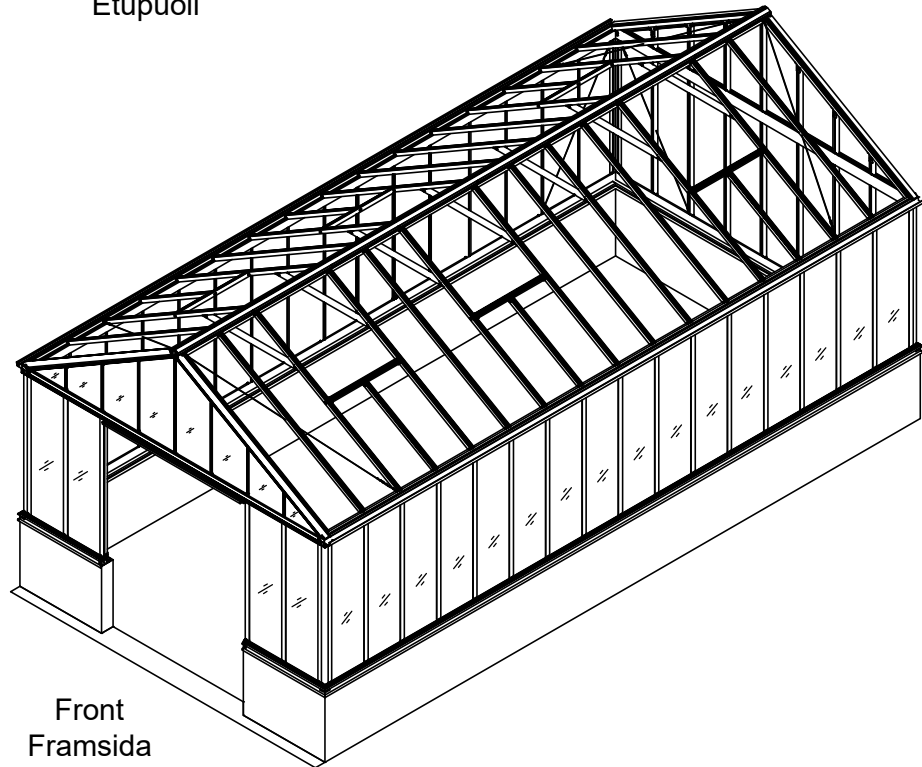
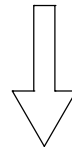

324×203
354×420
354×635
354×852
354×635
354×420
324×203

Front
Framsida
Forside
Framsida
Etuoli



Front
Framsida
Forside
Framsida
Etuoli

Part	NO.	QTY.	Length(MM)
	40X-Y03	1	859
	40X-Y04R	1	418
	40X-Y04L	1	418
	40X-Y05R	1	1715
	40X-Y05L	1	1715

Part	NO.	QTY.	Length(MM)	CTN NO.
	50X-Y04R	1	633	3140P-S
	50X-Y04L	1	633	3140P-S
	40X-Y04A-R	1	201	3140P-S
	40X-Y04A-L	1	201	3140P-S

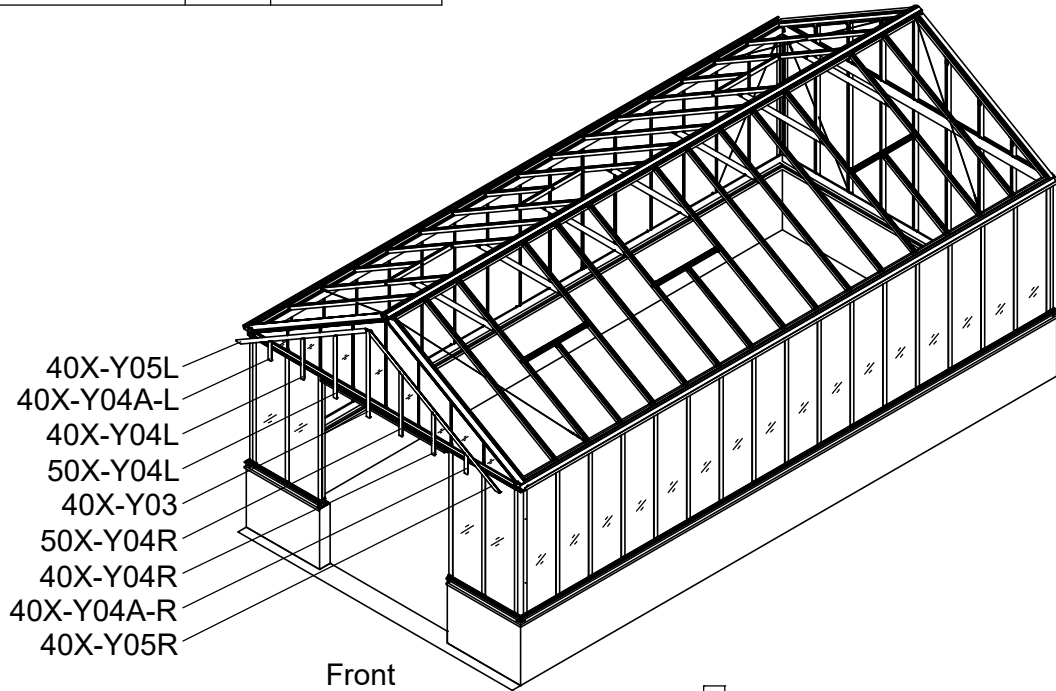



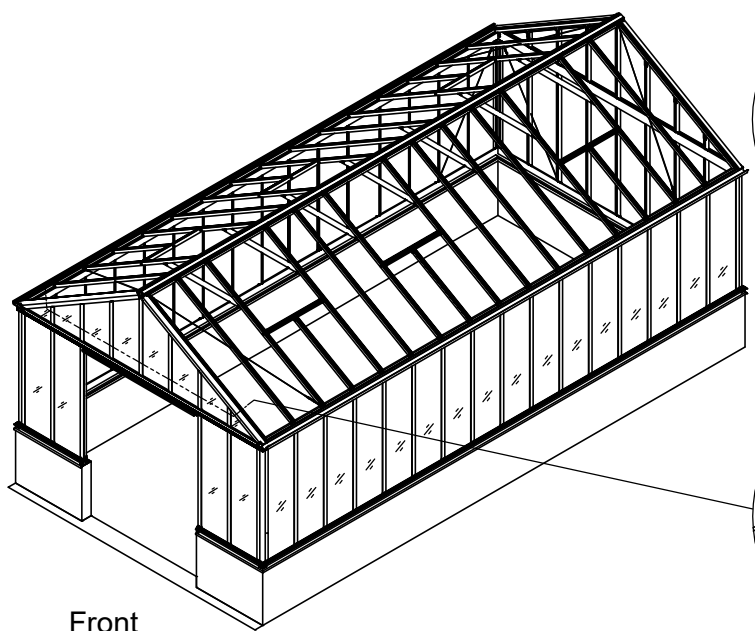
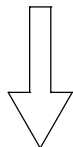

Front
Framsida
Forside
Framsida
Etupuoli

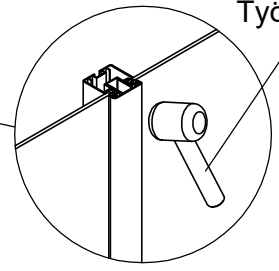
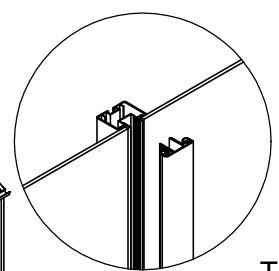

Front
Framsida
Forside
Framsida
Etupuoli



Tool
Verktøy
Værktøj
Verktøy
Työkalu

Part	NO.	QTY.	Length(MM)
	324×203	2	324
	354×420	2	420
	354×635	2	635
	354×852	2	852

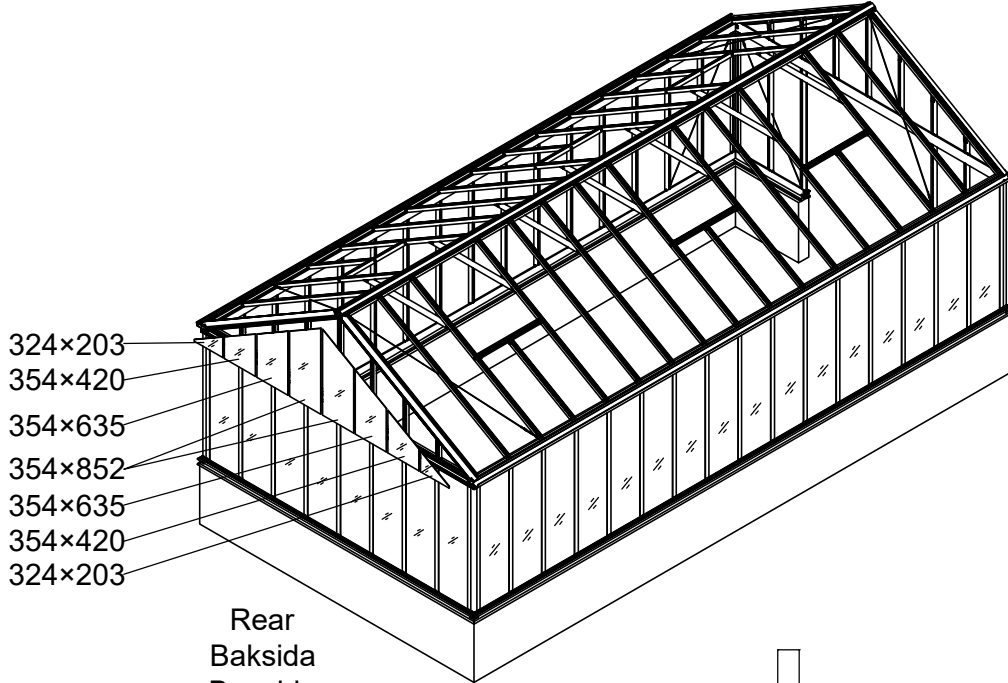



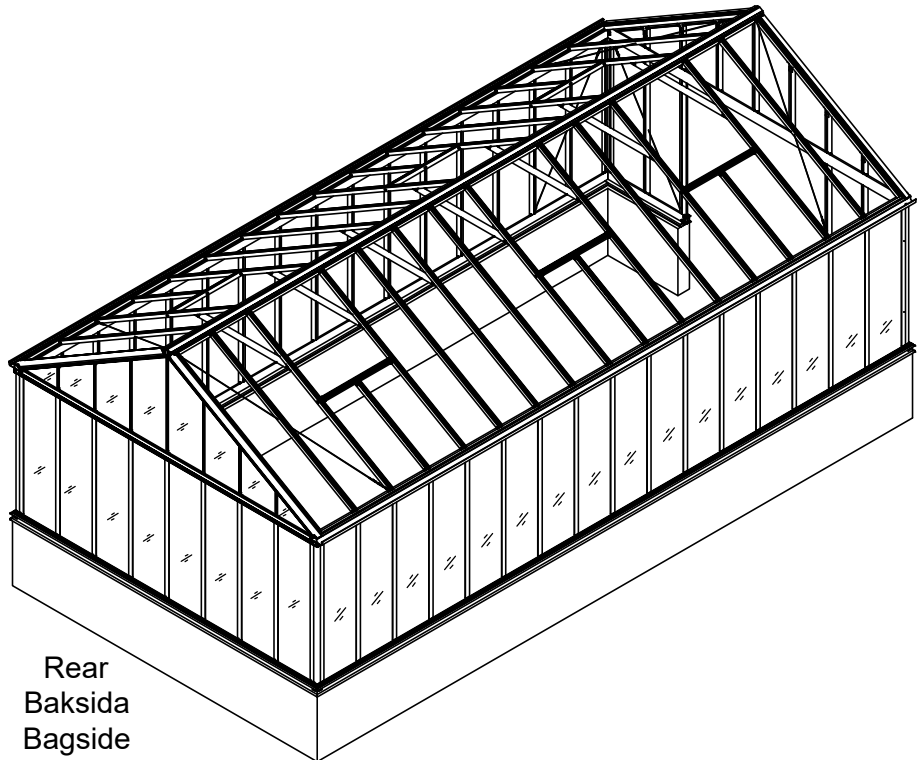
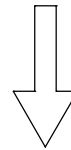

Rear
Baksida
Bagside
Baksida
Takapuoli





Rear
Baksida
Bagside
Baksida
Takapuoli

Part	NO.	QTY.	Length(MM)
	40X-Y03	1	859
	40X-Y04R	1	418
	40X-Y04L	1	418
	40X-Y05R	1	1715
	40X-Y05L	1	1715

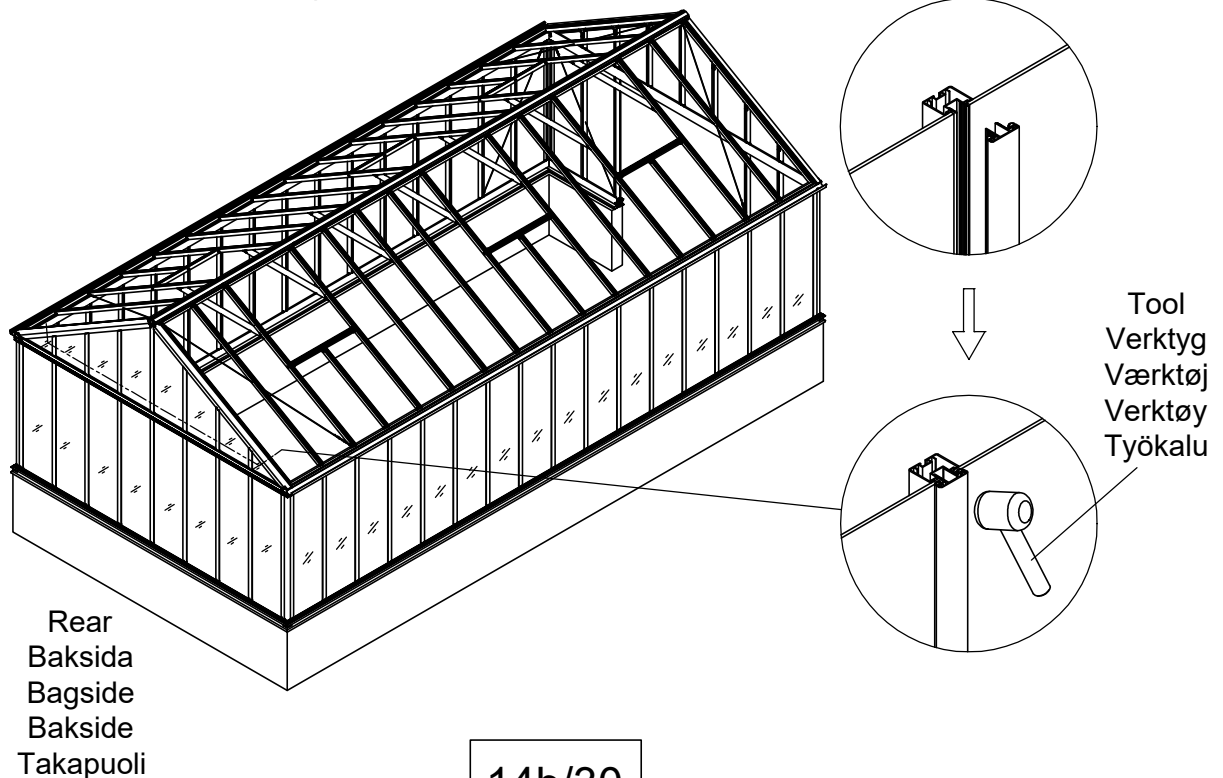
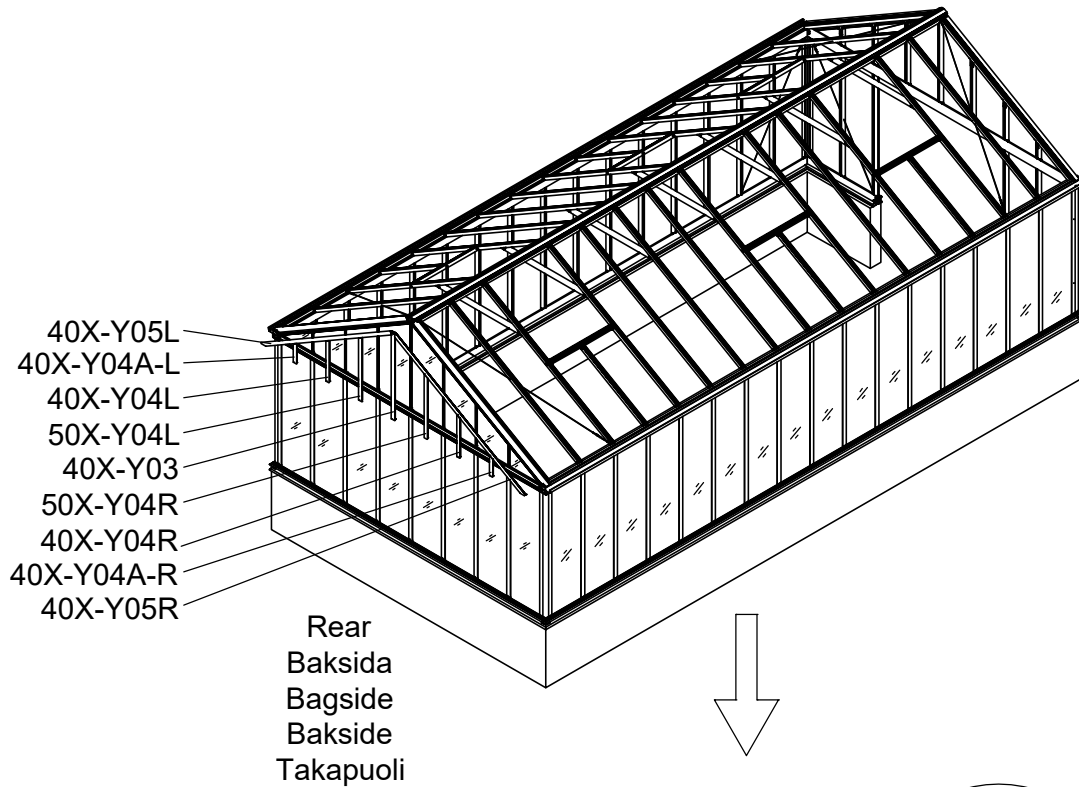
Part	NO.	QTY.	Length(MM)	CTN NO.
	50X-Y04R	1	633	3140P-S
	50X-Y04L	1	633	3140P-S
	40X-Y04A-R	1	201	3140P-S
	40X-Y04A-L	1	201	3140P-S



Part	NO.	QTY.					Length(MM)
		3051	3052	3053	3058	3059	
	354×1764	12	12	16	16	20	1764
	354×887	4	8	8	12	12	887

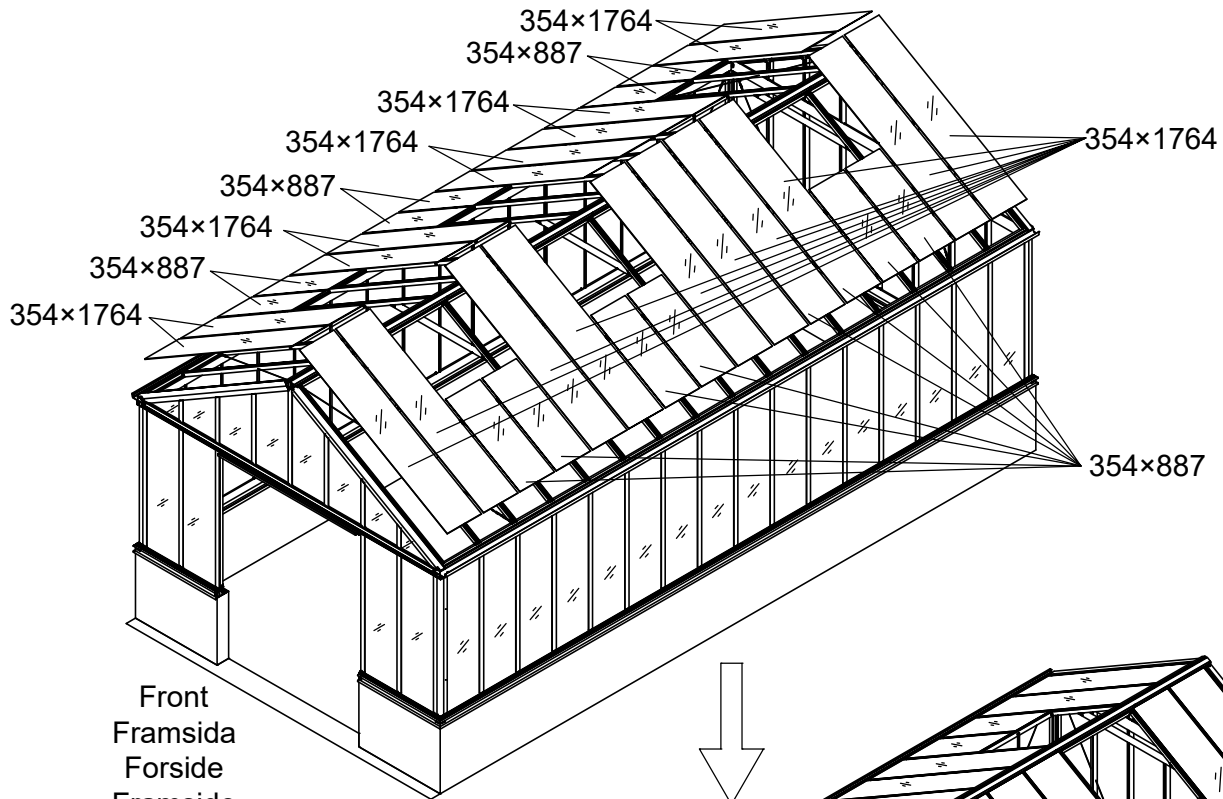

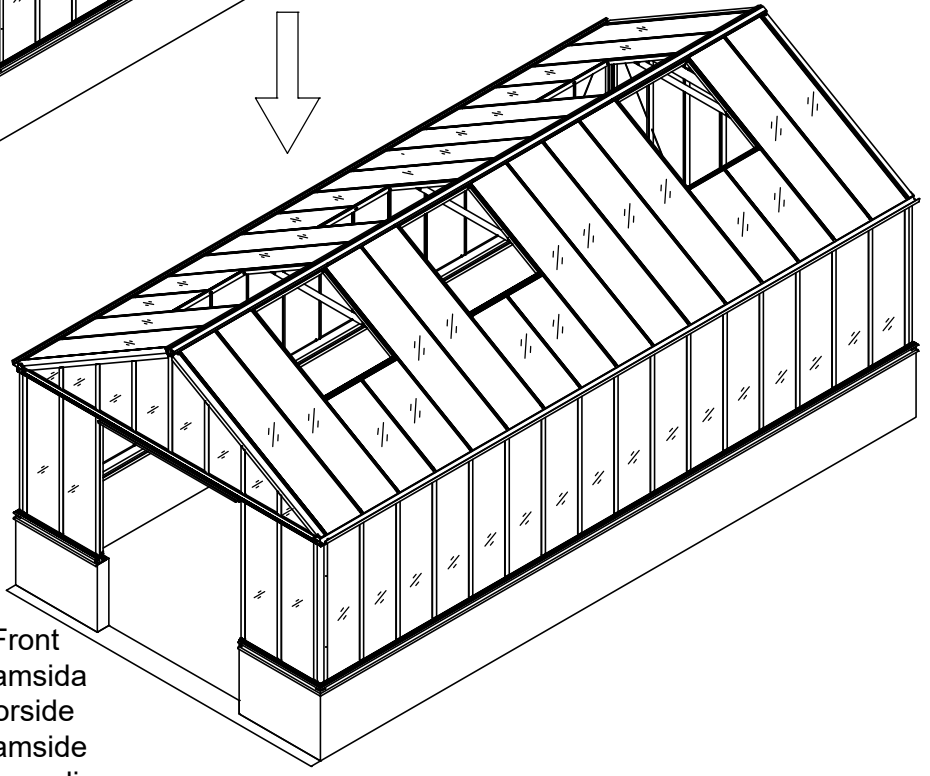

Front
Framsida
Forside
Framsida
Etupuoli



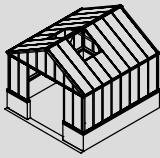
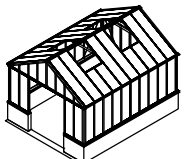
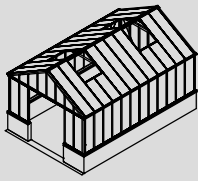
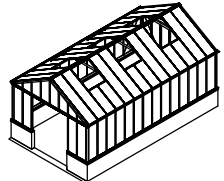
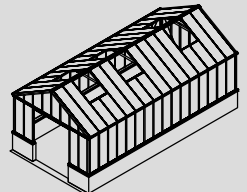

Front
Framsida
Forside
Framsida
Etupuoli

3051	3052	3053	3058	3059
				

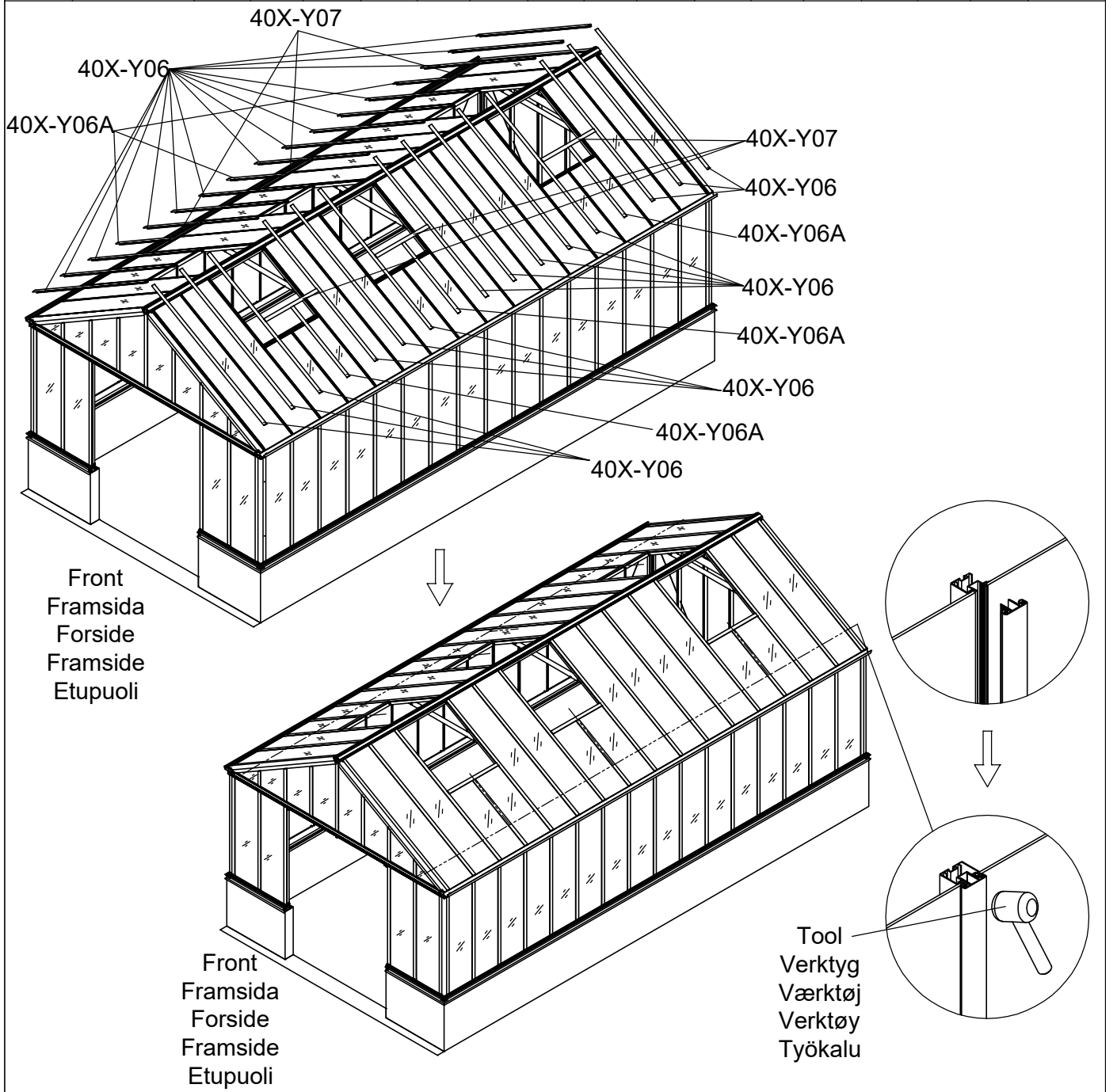

15a/30

Part	NO.	QTY.															Length (MM)
		3051			3052			3053			3058			3059			
		3051	3140P-S	3140P-S-2	3052	3140P-S	3140P-S-2	3053	3140P-S	3140P-S-2	3058	3140P-S	3140P-S-2	3059	3140P-S	3140P-S-2	
	40X-Y06	10	6	0	12	6	0	14	6	2	16	6	2	18	6	4	1756
	40X-Y07	2	0	0	4	0	0	4	0	0	6	0	0	6	0	0	712
	40X-Y06A	0	2	0	0	2	2	0	2	2	0	2	4	0	2	4	878

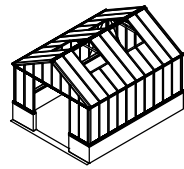
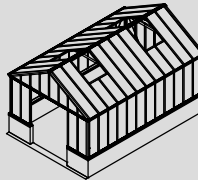
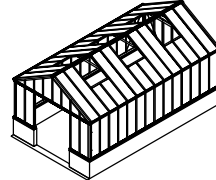
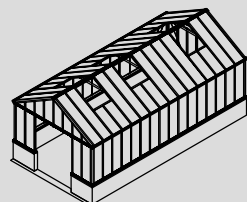

3051	3052	3053	3058	3059
				

15b/30

Part	NO.	QTY.					Length(MM)
		3051	3052	3053	3058	3059	
	7C26-009A	5M	5M	6.5M	6.5M	8M	
	7C26-007N	6M					

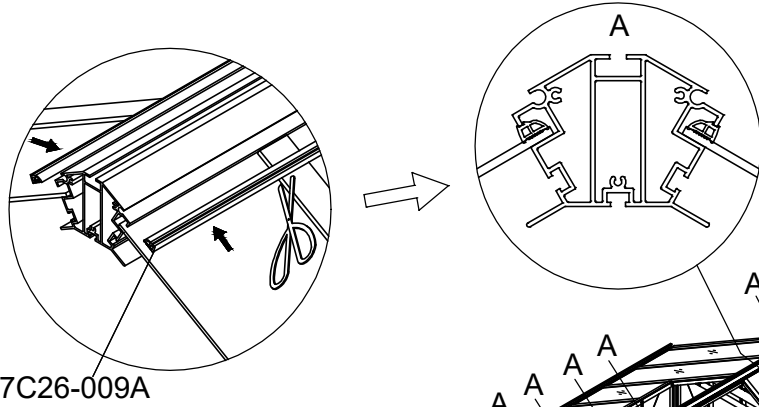

7C26-009A

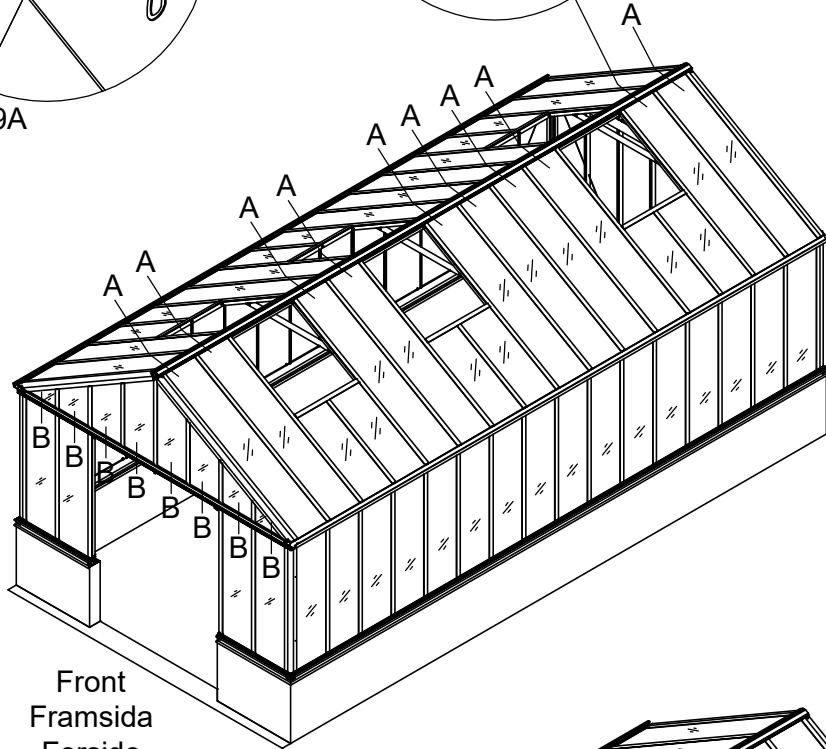

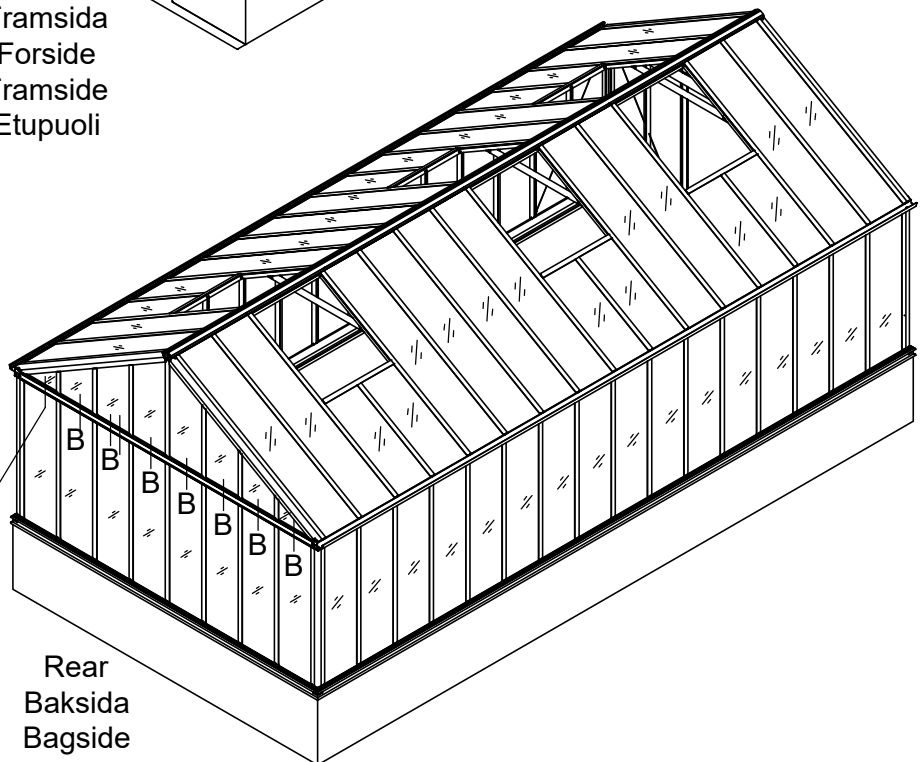
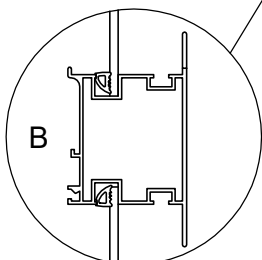
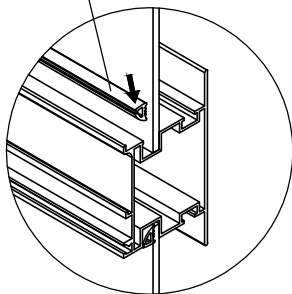

Front
Fransida
Forside
Franside
Etupuoli

7C26-007N



Rear
Baksida
Bagside
Baksida
Takapuoli

Part	NO.	QTY.	Length(MM)
	40X-Y60-A	1	3023

Part	Product	NO.	Length (MM)	QTY.	Code
	3051	40X-Y62-4A	3132	2	A007
	3052	40X-Y62-5A	3883		
	3053	40X-Y62-6A	4634		
	3058	40X-Y62-7A	5385		
	3059	40X-Y62-8A	6136		

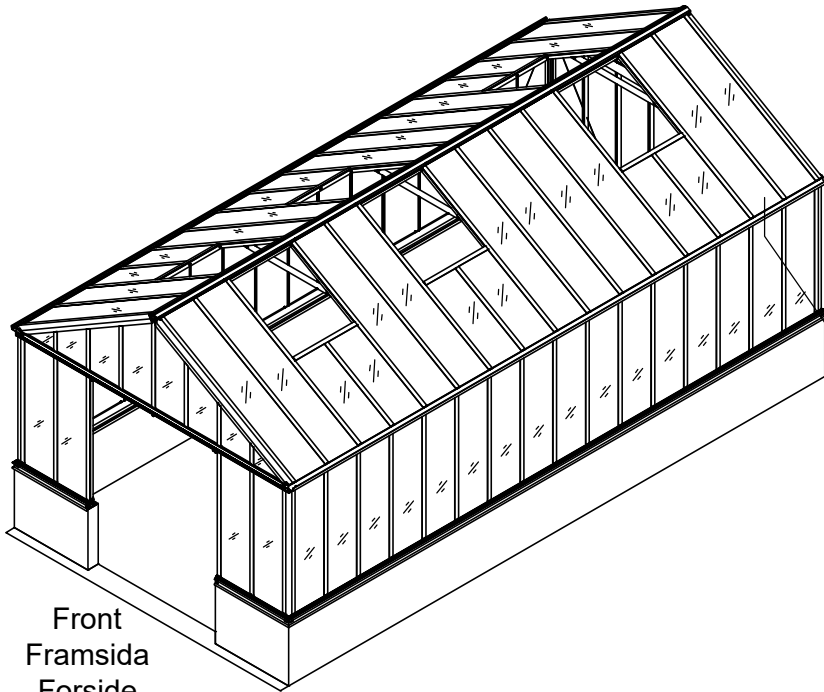

Front
Framsida
Forside
Framsida
Etuapuoli

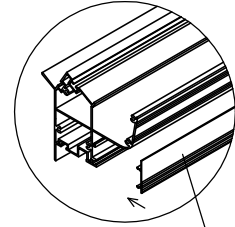



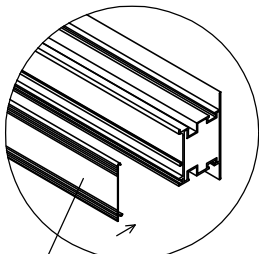
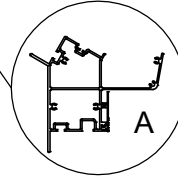



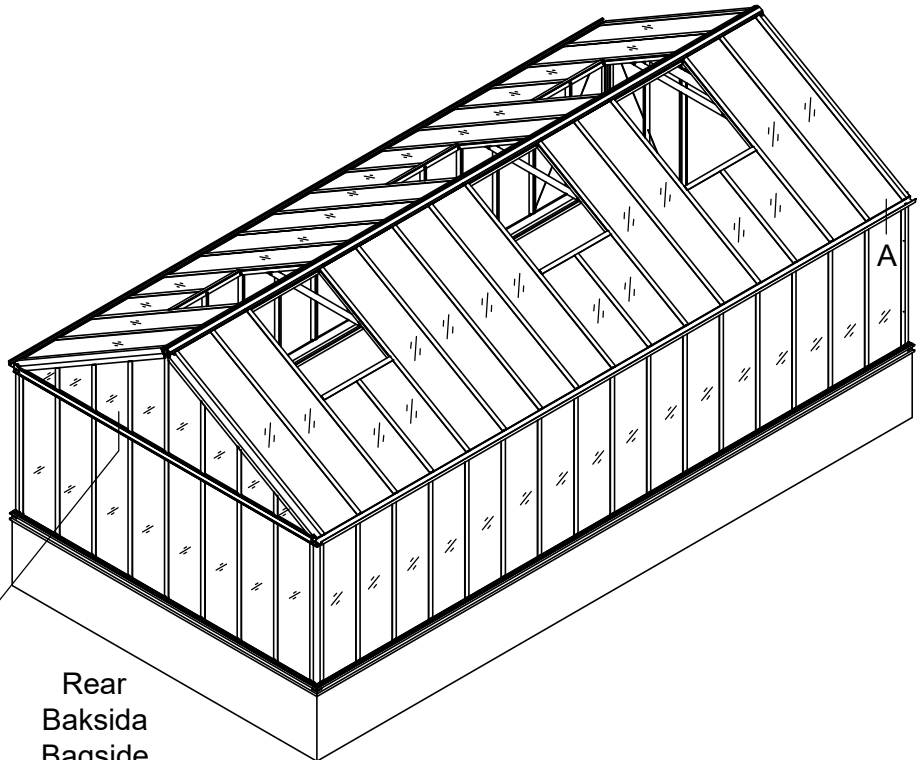
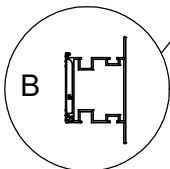

A007



40X-Y60-A



Rear
Baksida
Bagside
Baksida
Takapuoli

Part	NO.	QTY.	Length(MM)
	40A-Y90	2	1866
	40A-Y91R	1	1866
	40A-Y91L	1	1866
	40A-Y92R	1	769
	40A-Y92L	1	769
	40A-Y93	2	769
	W03	8	30
	W04	16	PCS

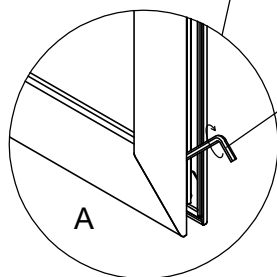
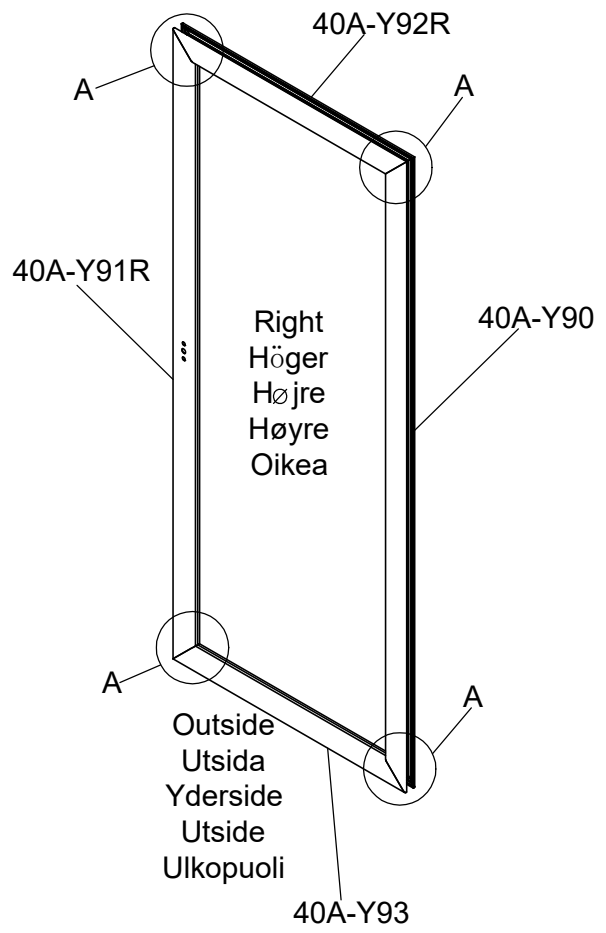
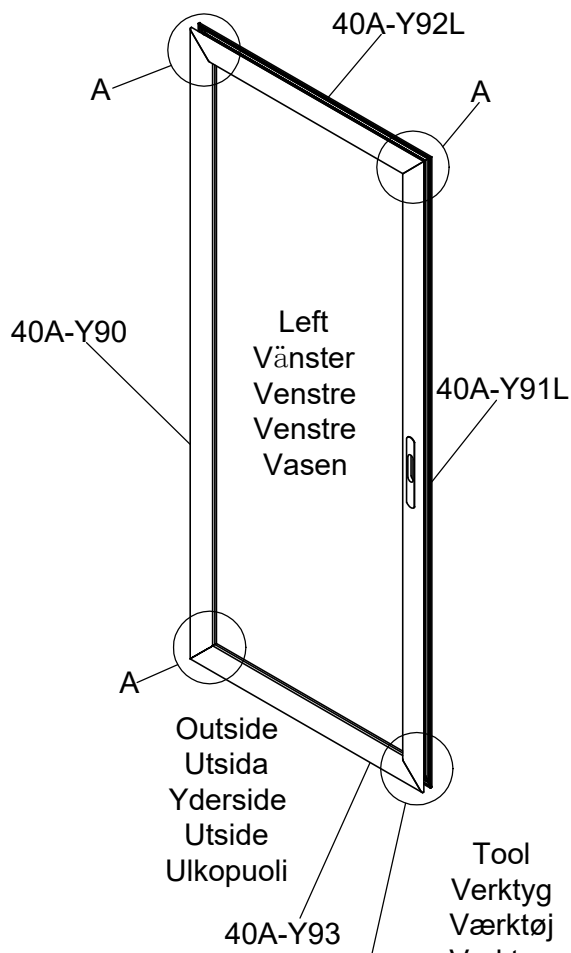

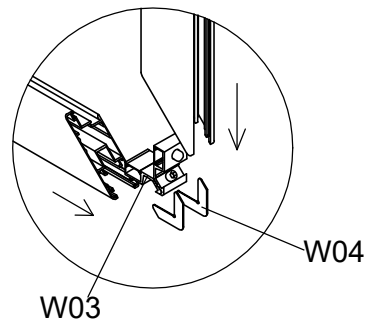

Tool
Verktøj
Værktøj
Verktøy
Työkalu

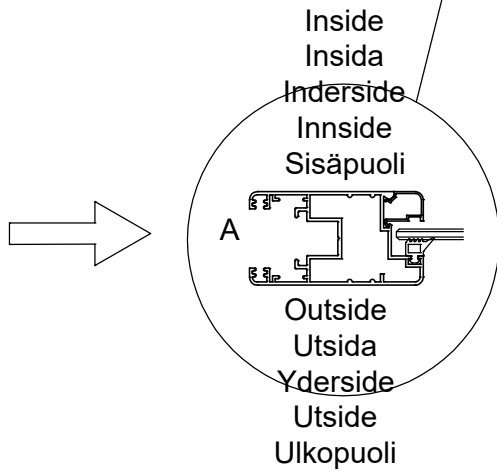
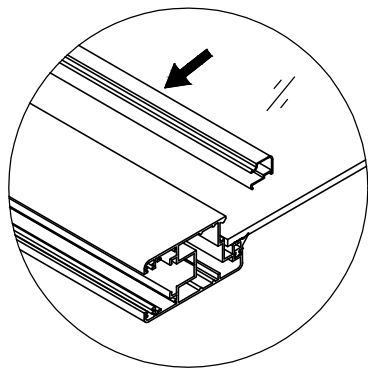
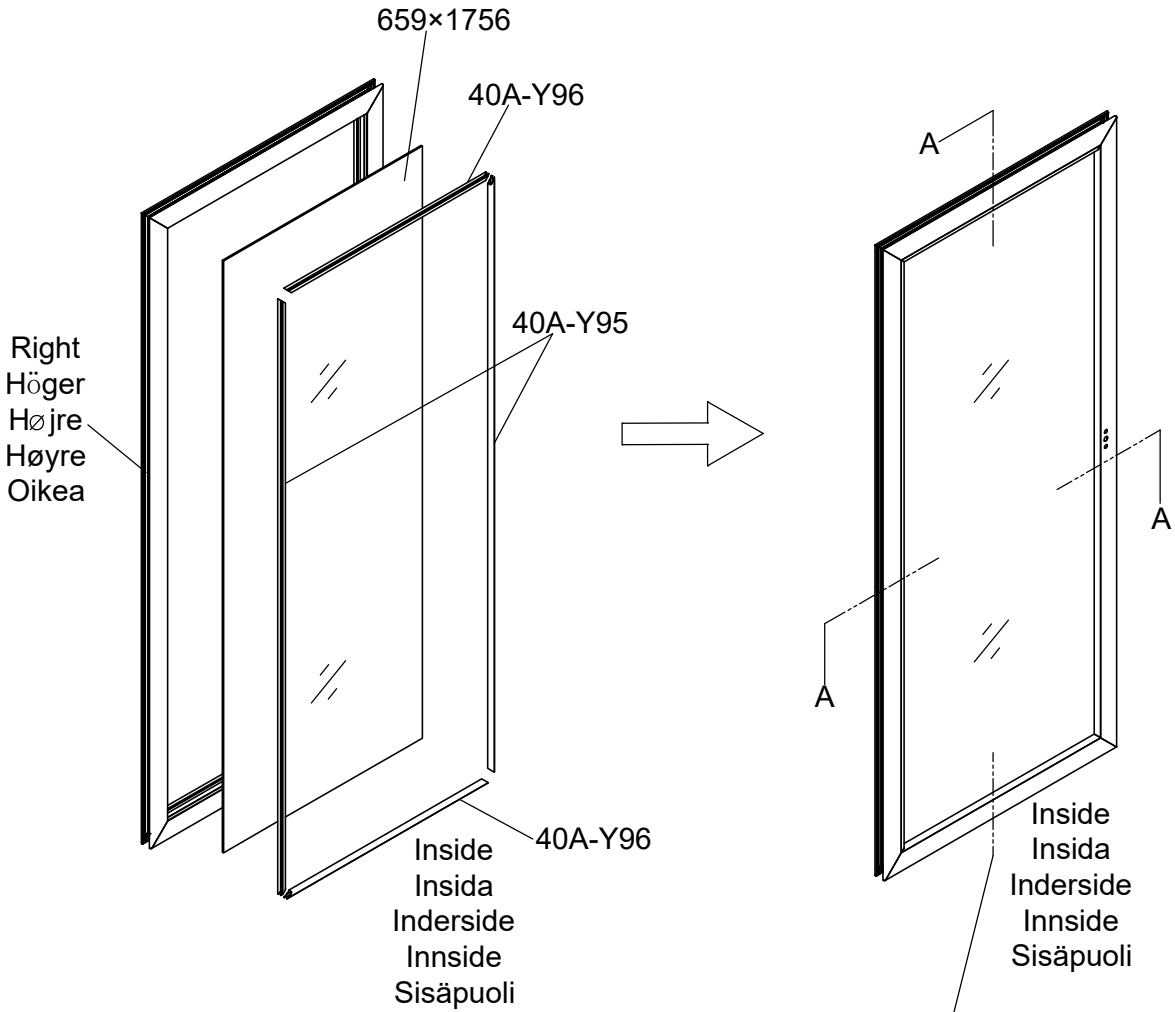

Part	NO.	QTY.	Length(MM)
	659×1756	1	1756
	40A-Y95	2	1765
	40A-Y96	2	668



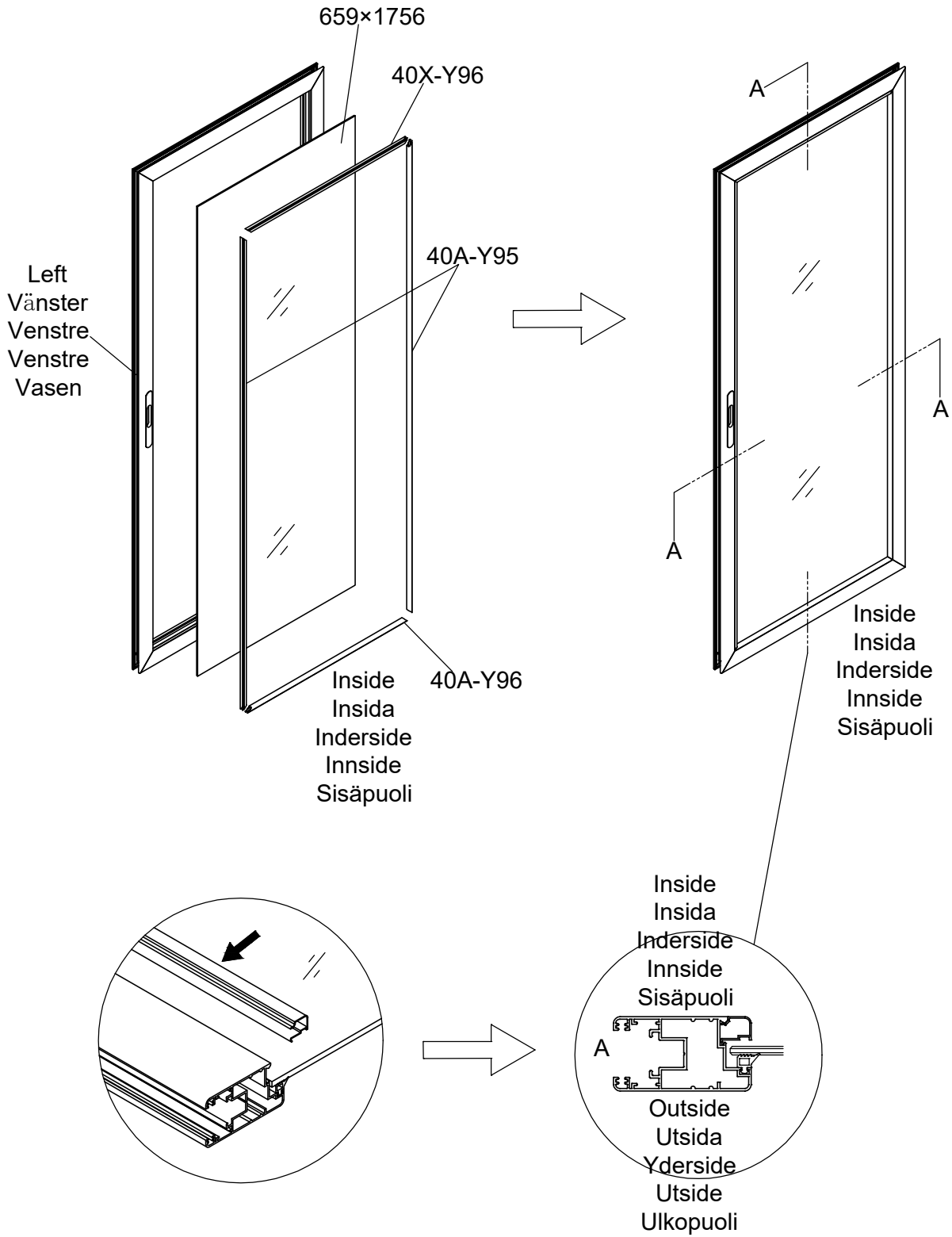

Part	NO.	QTY.	Length(MM)
	659×1756	1	1756
	40A-Y95	2	1765
	40A-Y96	2	668



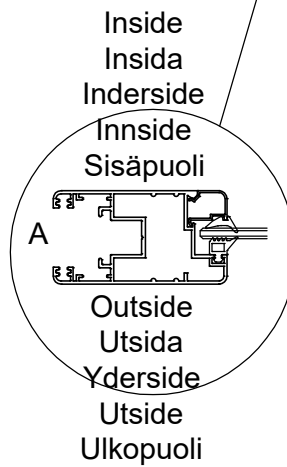
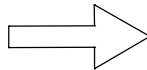
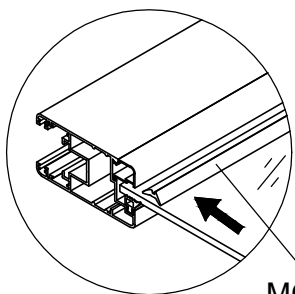
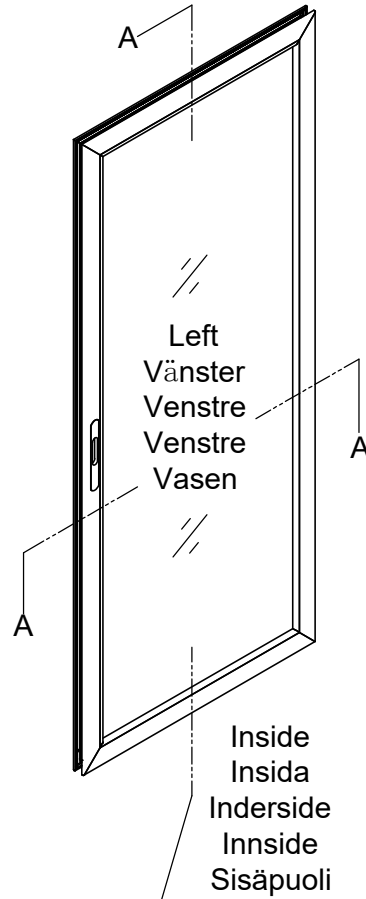
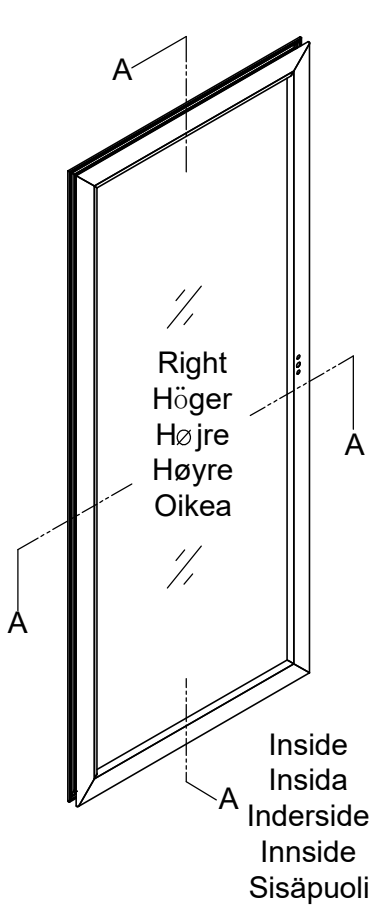

Part	NO.	QTY.	Length(MM)
	MCJT002	11M	



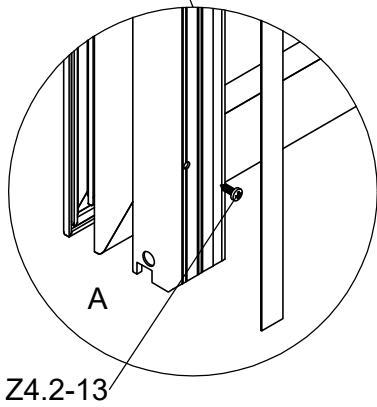
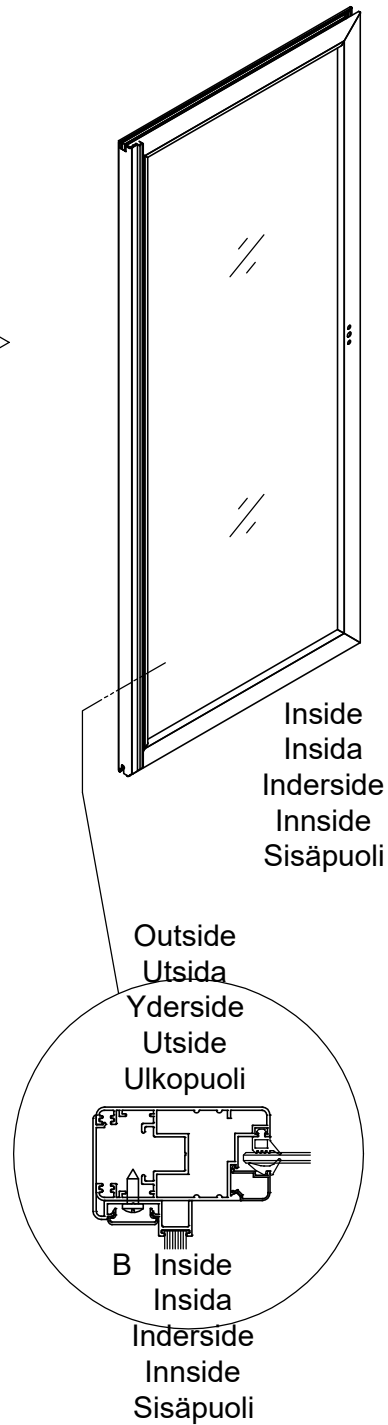
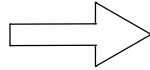
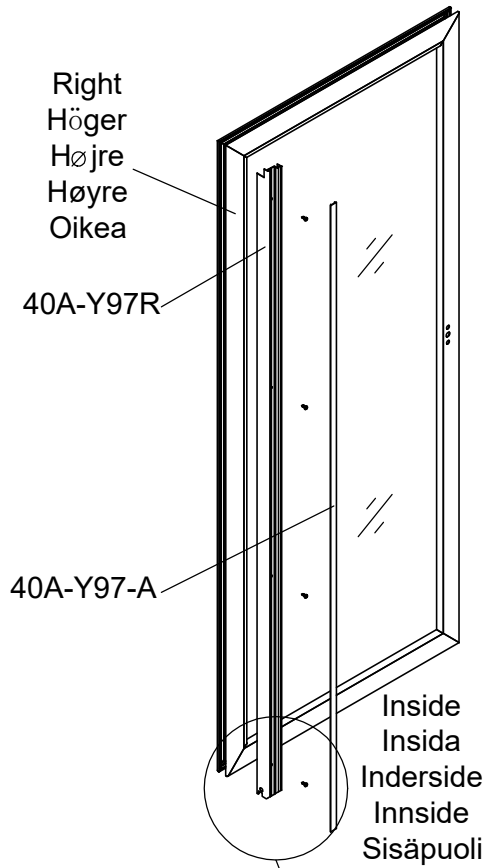



Part	NO.	QTY.	Length(MM)
	40A-Y97R	1	1860
	40A-Y97-A	1	1851
	Z4.2-13	4	PCS

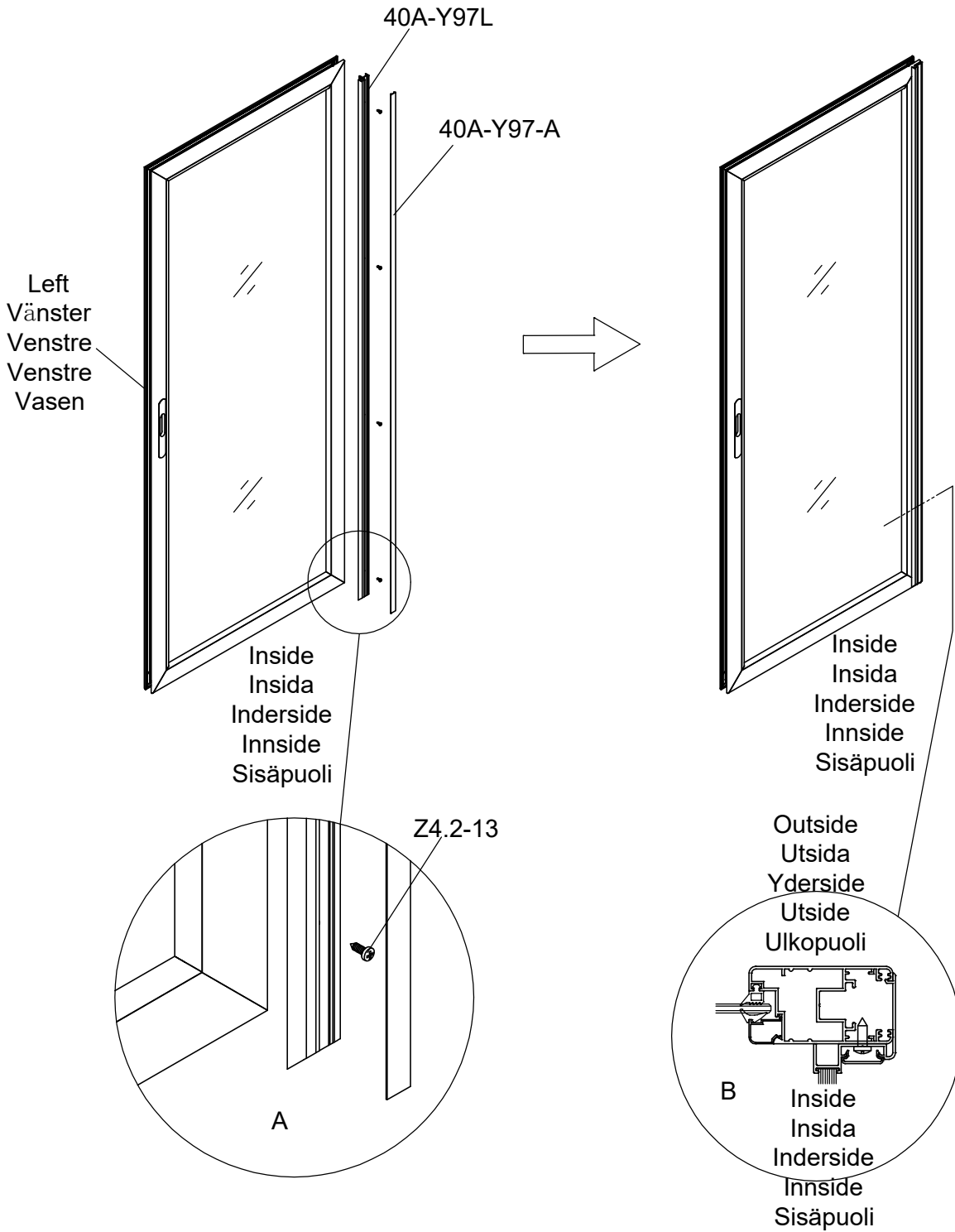



Part	NO.	QTY.	Length(MM)
	40A-Y97L	1	1860
	40A-Y97-A	1	1851
	Z4.2-13	4	PCS

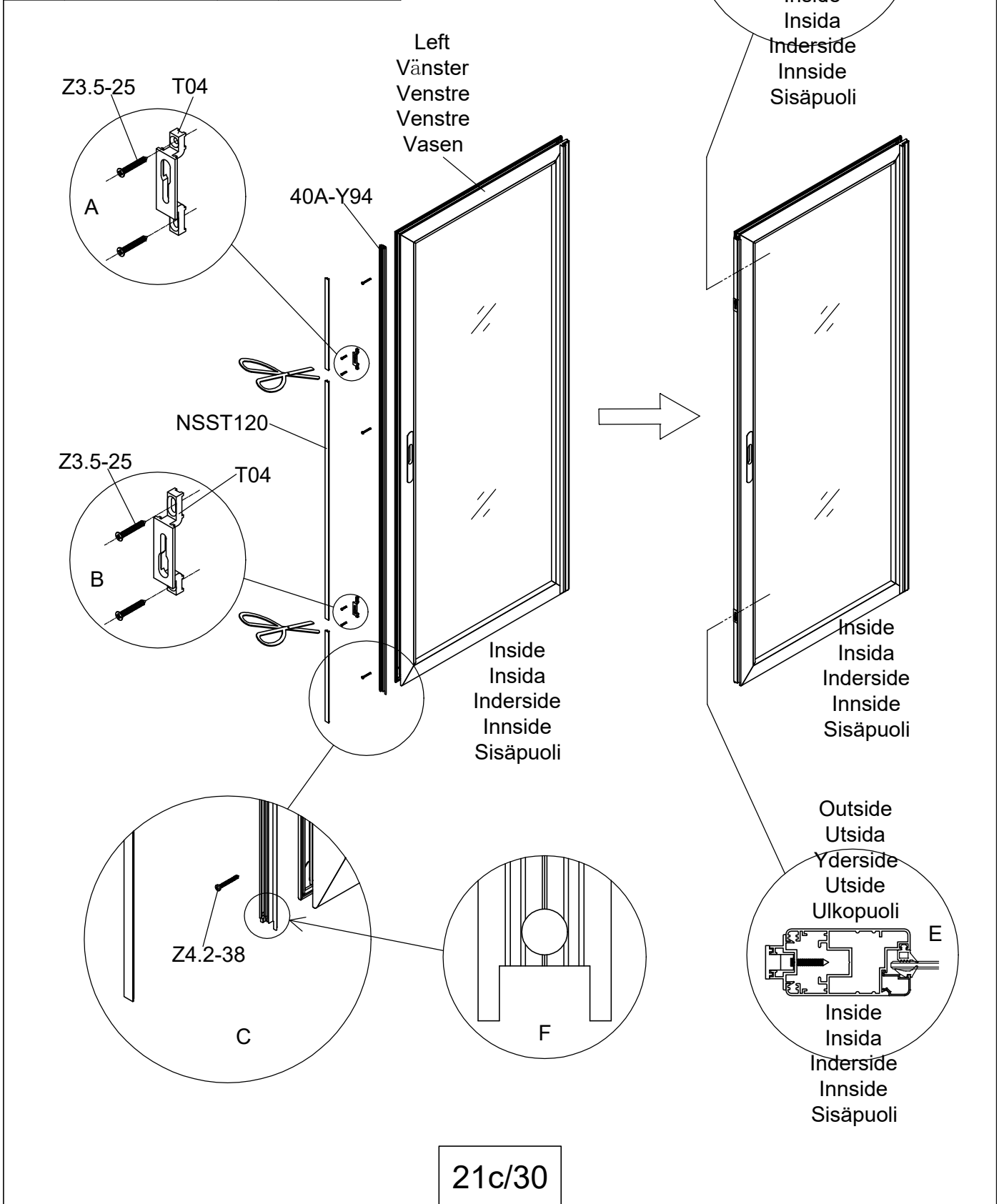

Part	NO.	QTY.	Length(MM)
	40A-Y94	1	1835
	NSST120	1.9M	
	T04	2	PCS
	Z4.2-38	3	PCS
	Z3.5-25	4	PCS



Part	NO.	QTY.	Length(MM)
	40A-Y98-R	1	1910
	40A-Y98-L	1	1910
	M6-35	2	PCS
	Si6-35	6	PCS
	J05	6	PCS

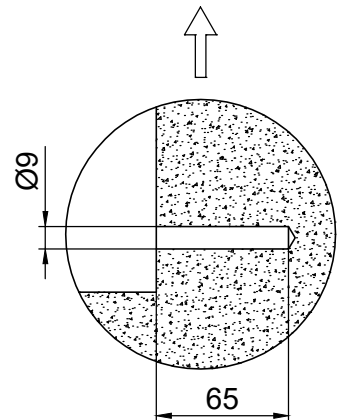
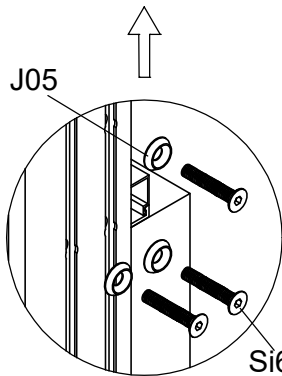
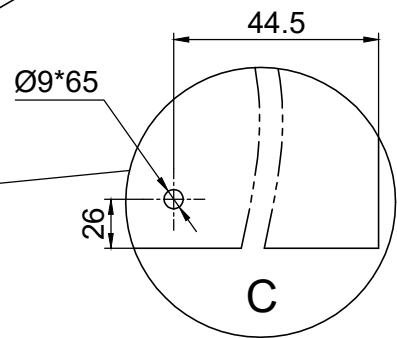
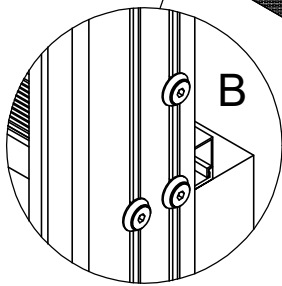
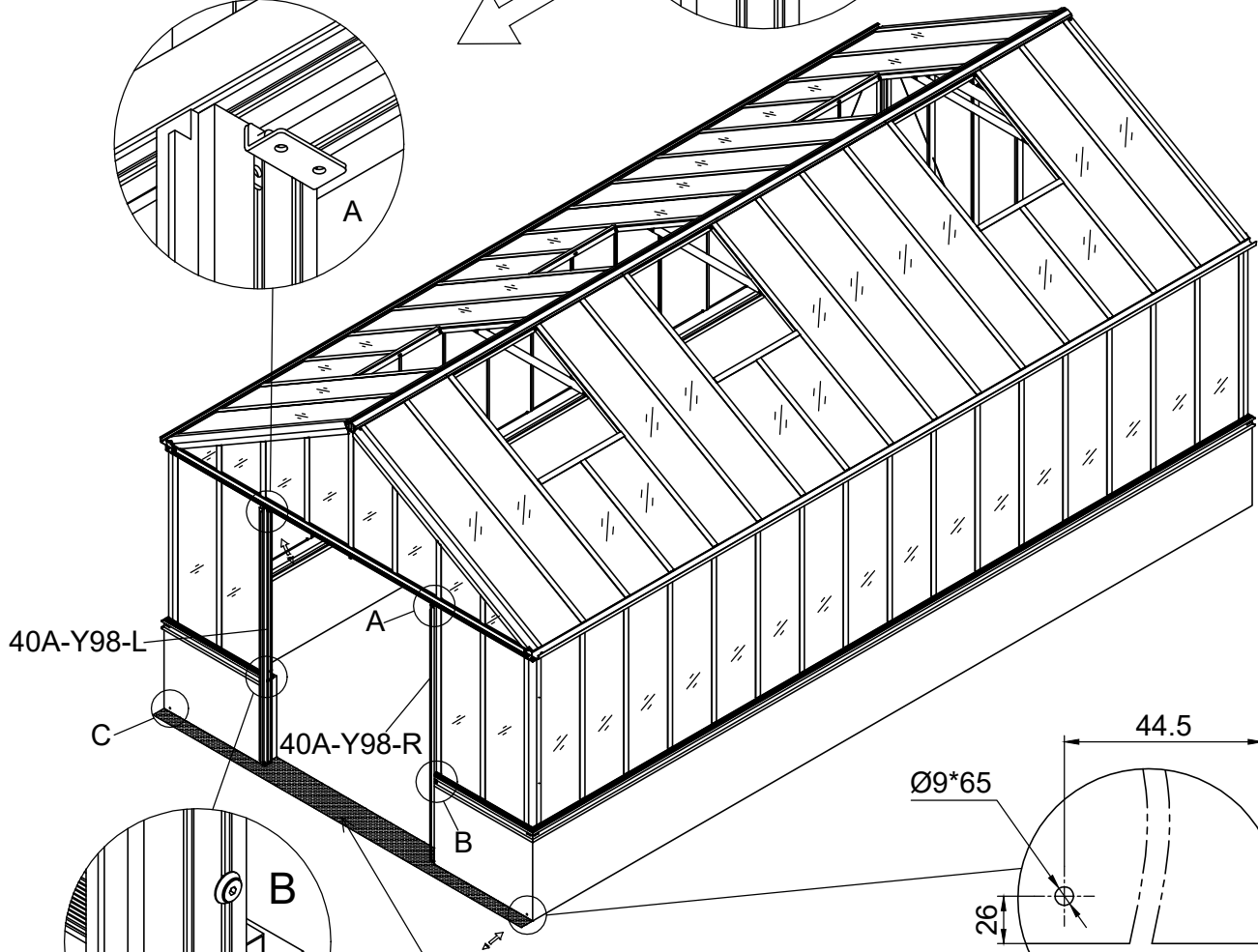
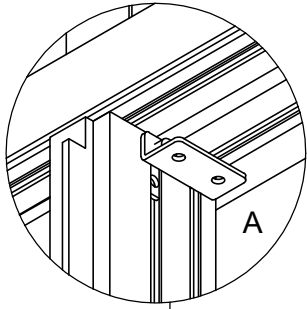
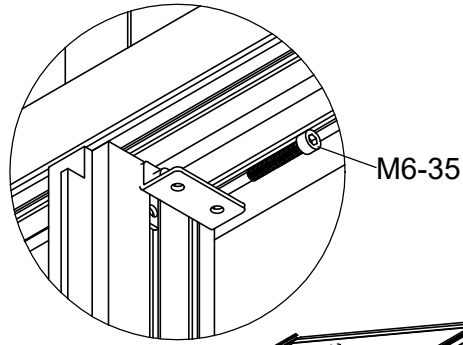





Make sure the floor below the doors frame should be flat and solid.

Se till att underlaget under dörrramen är plan och på solid grund.





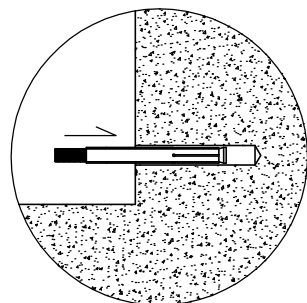
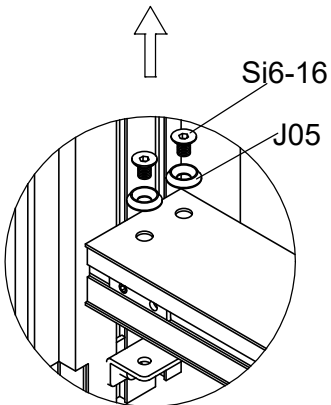
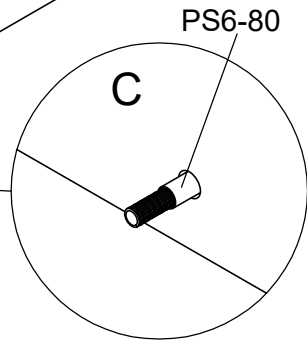
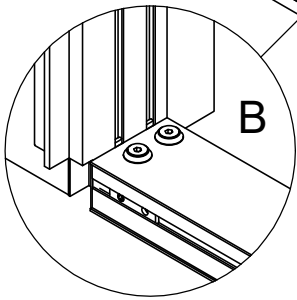
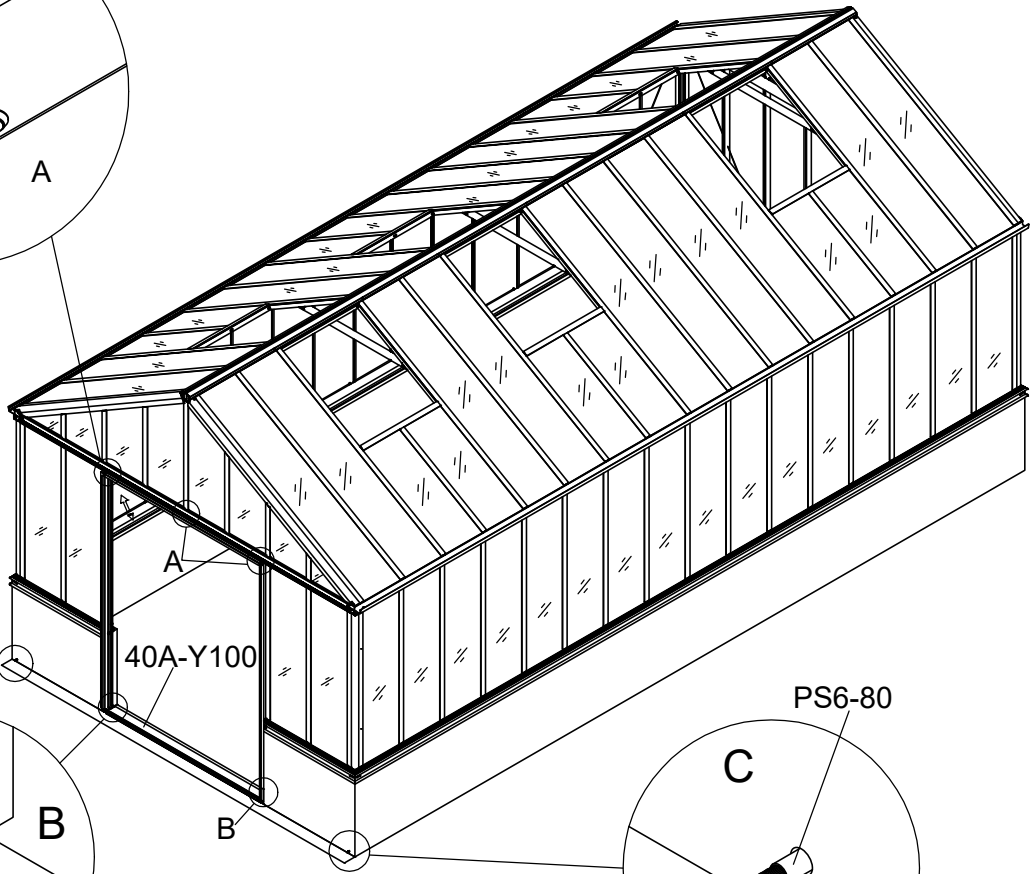
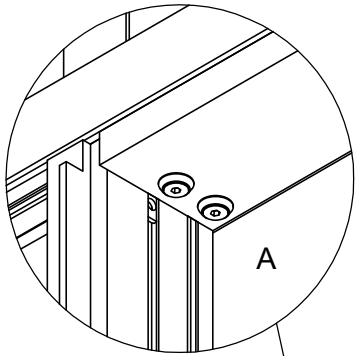
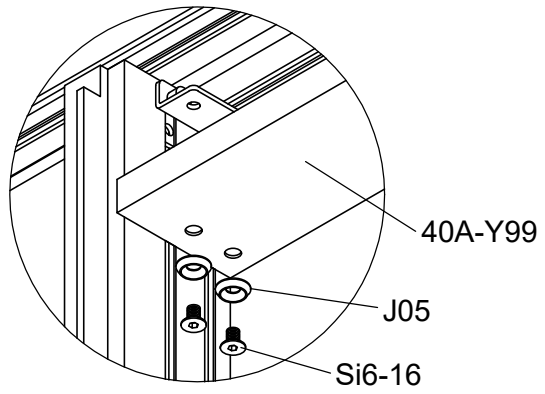

Sørg for, at underlaget under dørkarmen er plan og på fast grund.

Sørg for at underlaget under dørterskelen er slett og på solid fundament.



Tarkista, että maa ovikarmin alla on sileä ja tasainen.

Part	NO.	QTY.	Length(MM)
	40A-Y99	1	1424
	40A-Y100	1	1424
	Si6-16	10	PCS
	J05	10	PCS
	PS6-80	2	PCS

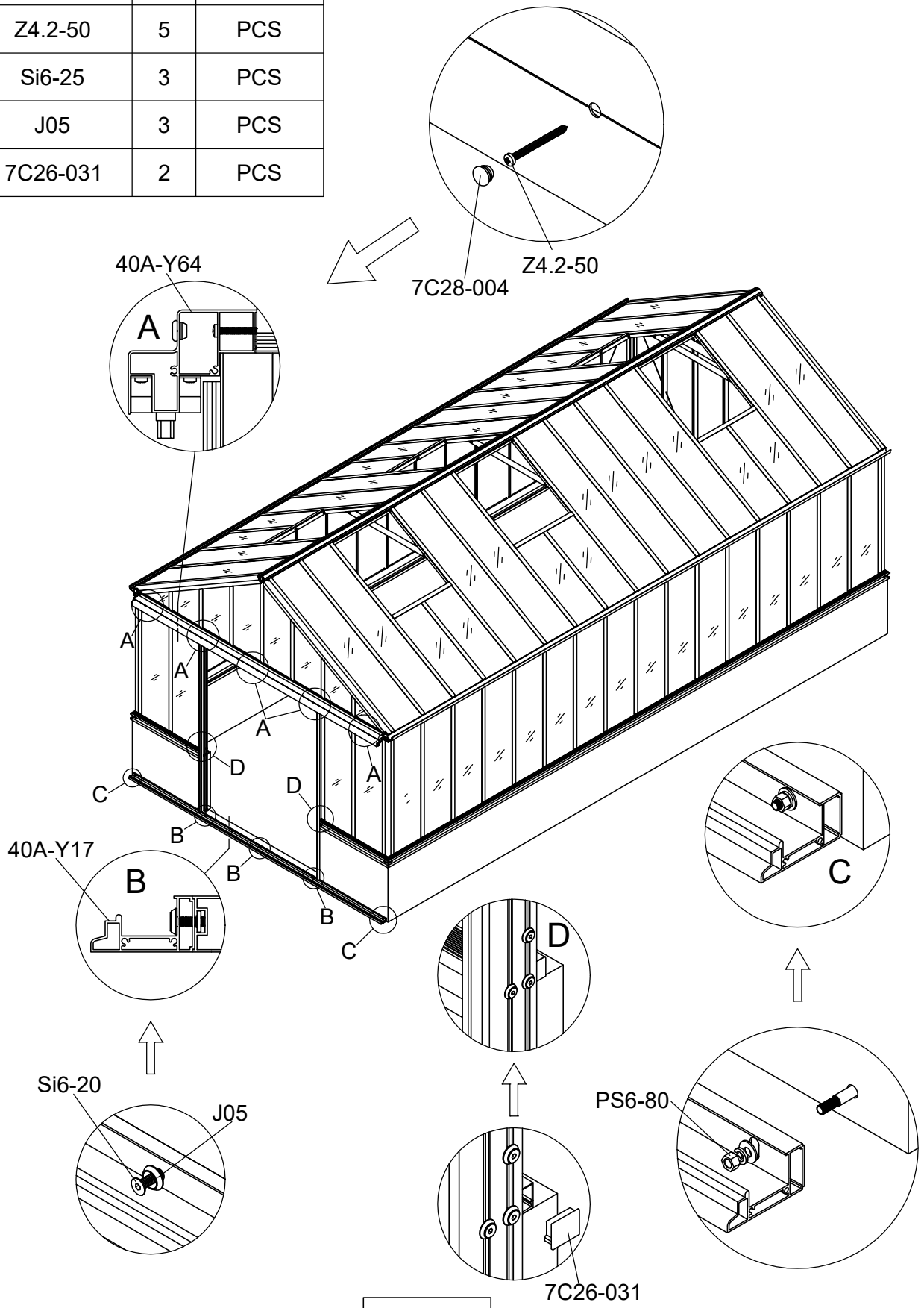

Part	NO.	QTY.	Length(MM)
	40A-Y64	1	3016
	40A-Y17	1	3110
	7C28-004	5	PCS
	Z4.2-50	5	PCS
	Si6-25	3	PCS
	J05	3	PCS
	7C26-031	2	PCS



Part	NO.	QTY.	Length(MM)
	40A-Y98A-R	1	1855
	40A-Y98A-L	1	1855

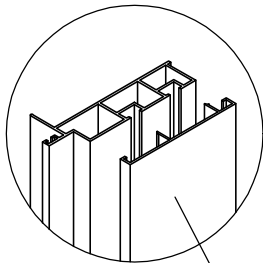
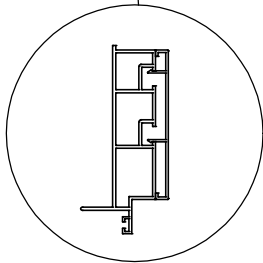
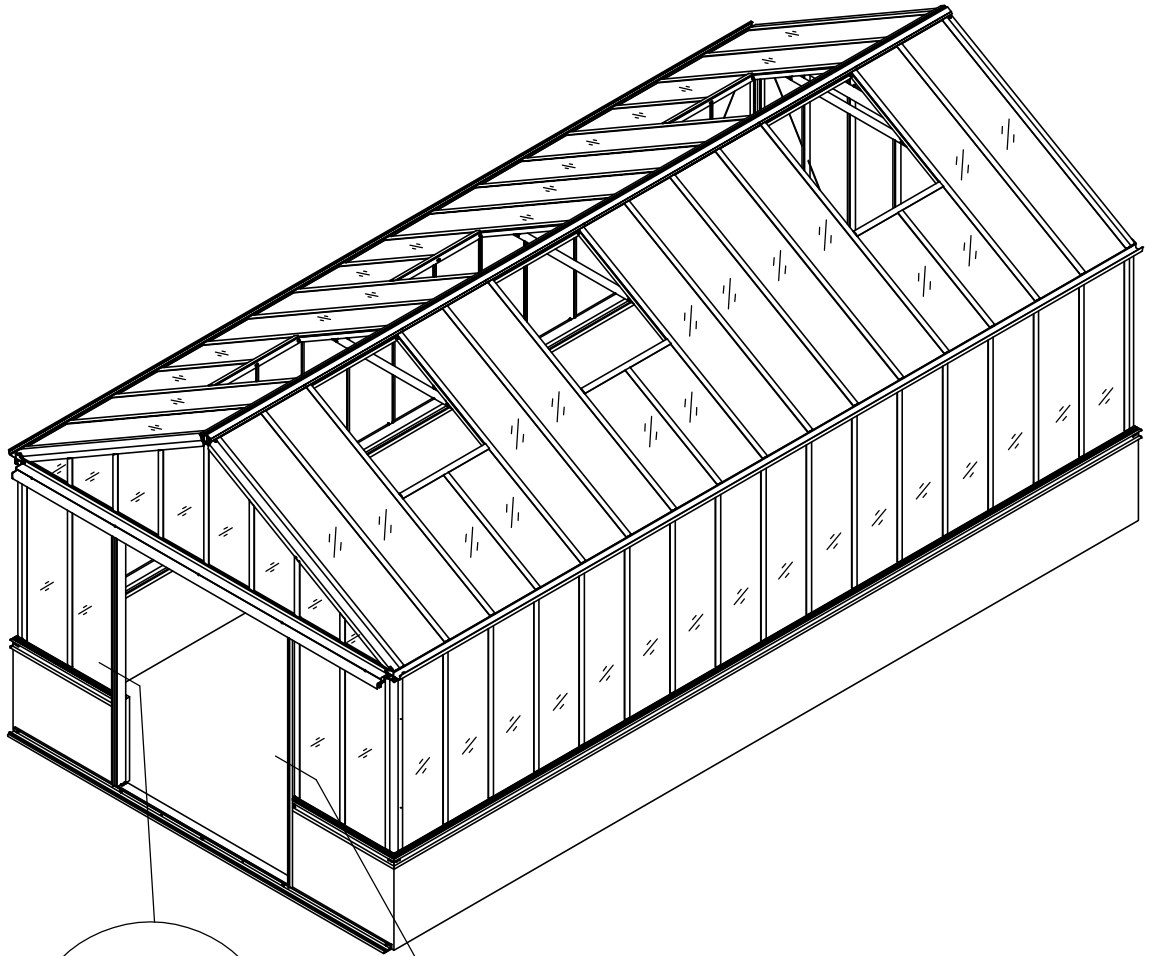

40A-Y98A-L

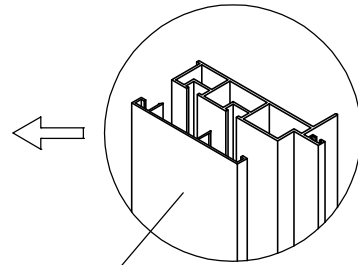
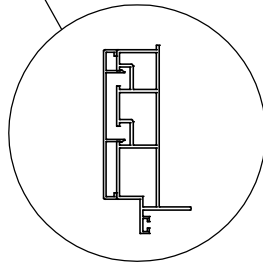

40A-Y98A-R

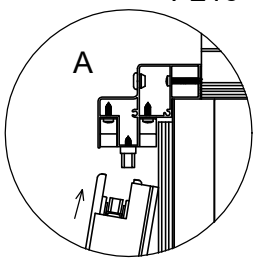
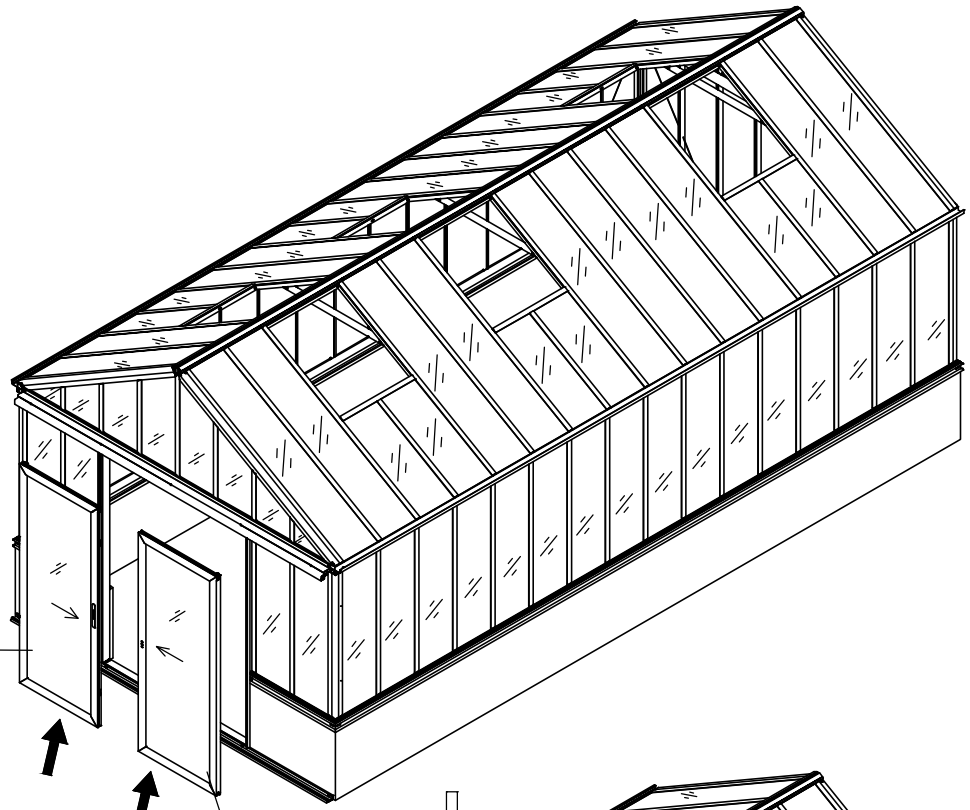

P21c

P21a

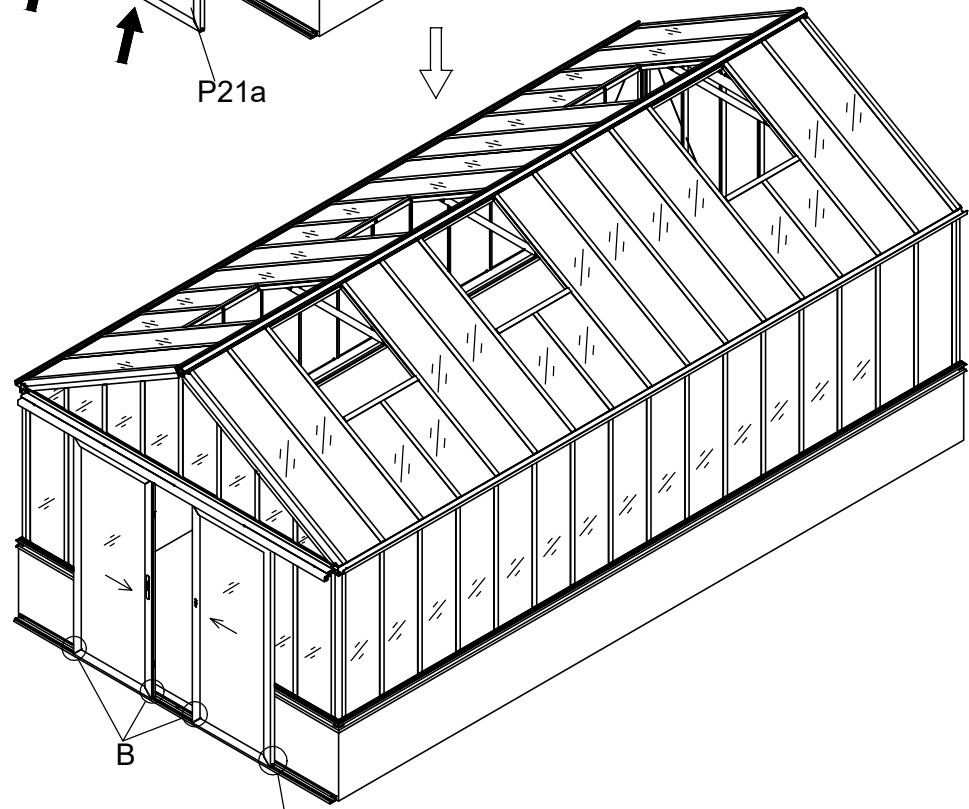

B

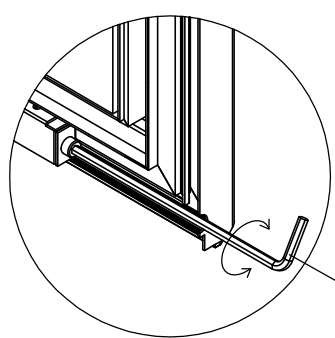



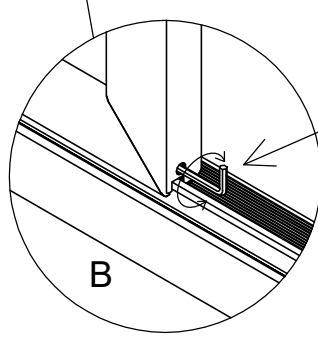





Tool
Verktøj
Værktøj
Työkalu









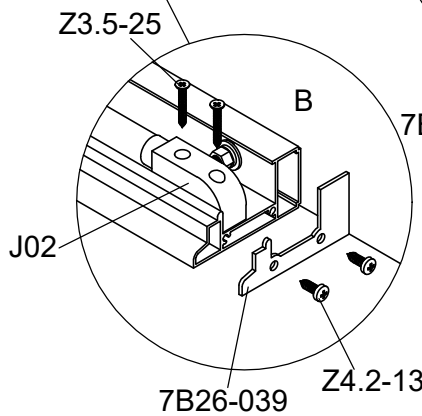
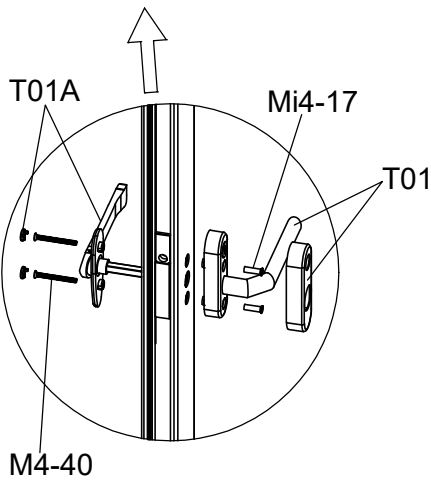
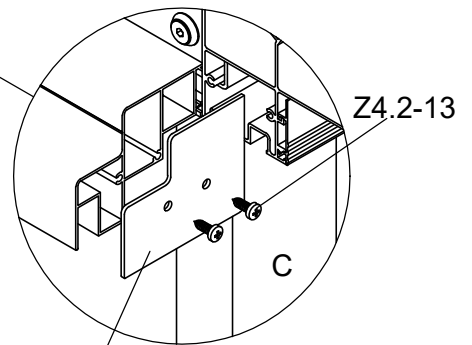
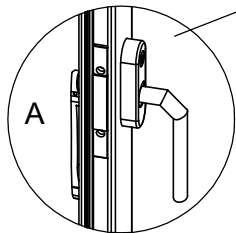
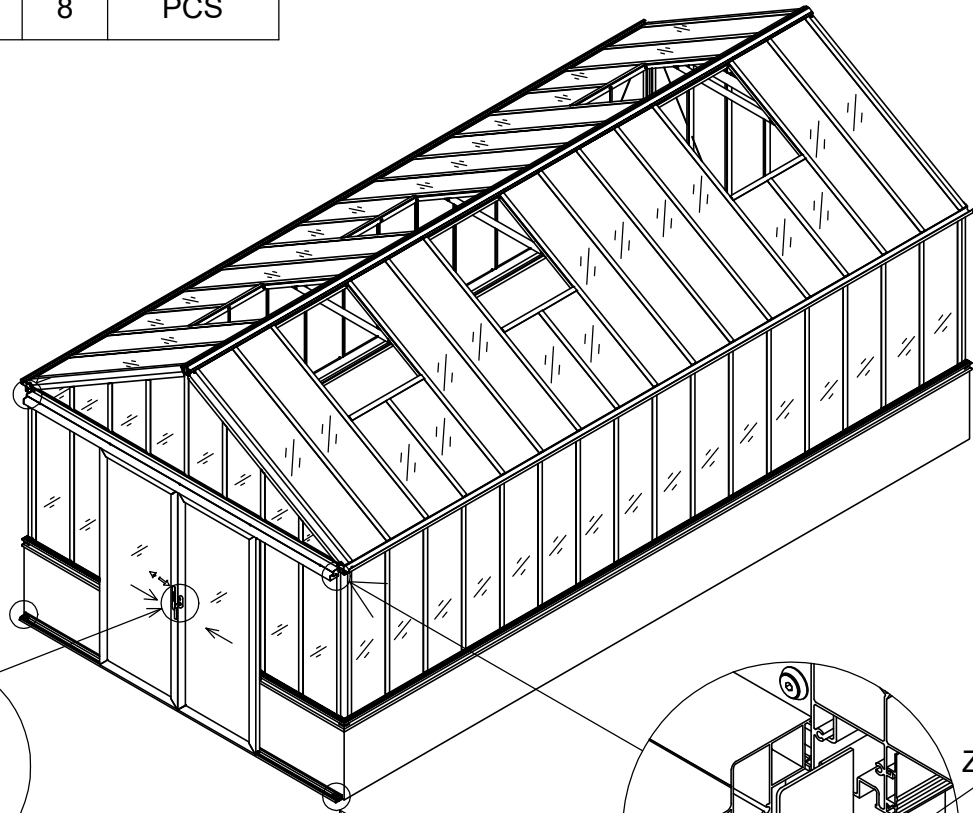

B



Adjust the height of the wheels
Justera höjden för hjulen
Juster højden af hjulene
Justere høyden for hjulene
Säädä alapyörien korkeus

Part	NO.	QTY.	Length(MM)
	T01	1	PCS
	T01A	1	PCS
	J02	2	PCS
	7B26-039	2	PCS
	7B26-038	2	PCS
	M4-40	2	PCS
	Mi4-17	2	PCS
	Z3.5-25	4	PCS
	Z4.2-13	8	PCS

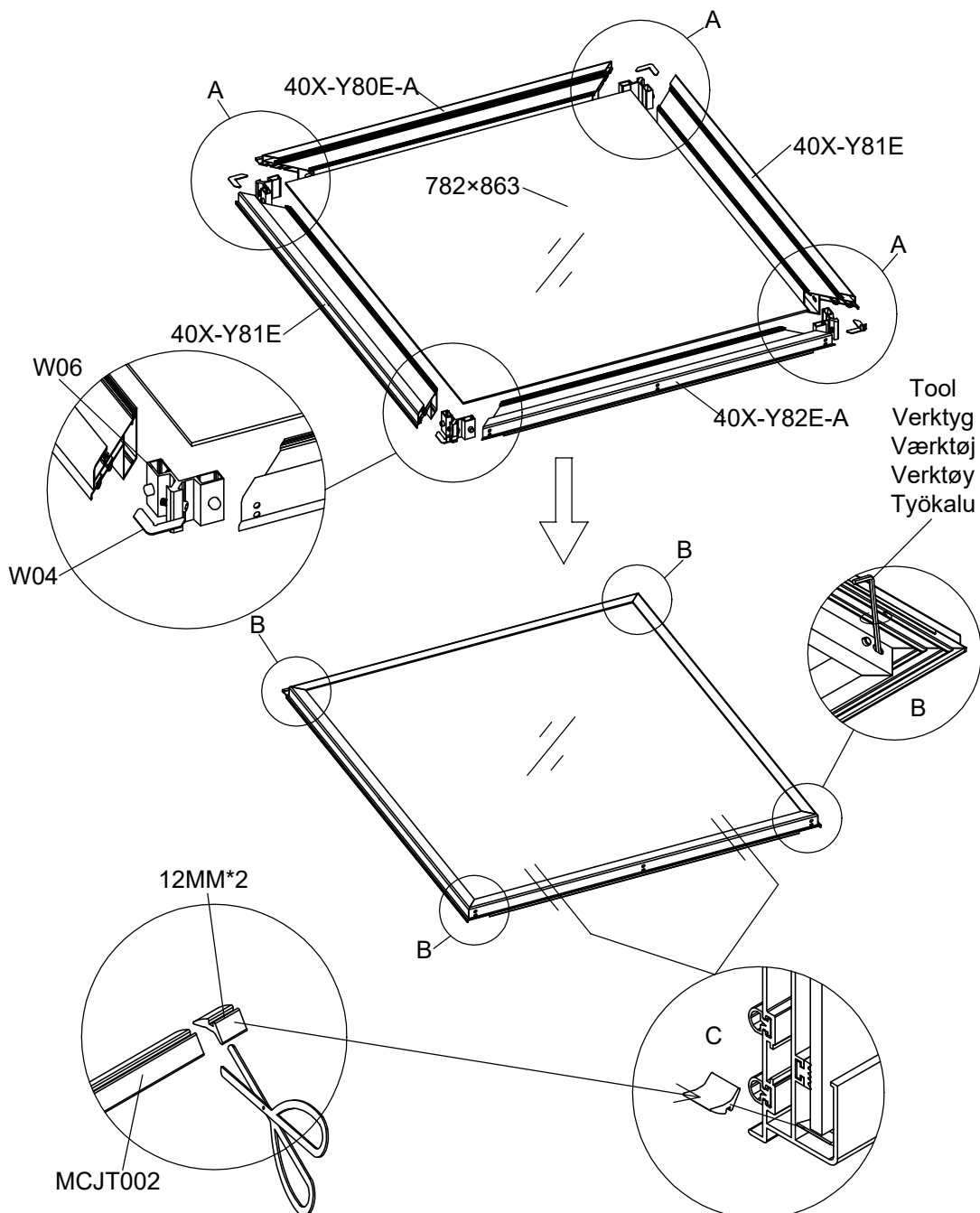

Part	NO.	QTY.					Length(MM)	CTN NO.
		3051	3052	3053	3058	3059		
	40X-Y80E-A	2	4	4	6	6	801	
	40X-Y81E	4	8	8	12	12	882	
	W06	8	16	16	24	24	46	
	W04	8	16	16	24	24	PCS	
	782x863	2	4	4	6	6	863	
	MCJT002	4	8	8	12	12	12	
	40X-Y82E-A	2	2	2	2	2	801	3149P-S
	40X-Y82E-A	0	2	2	4	4	801	3149P-S-2



Part	NO.	QTY.					Length(MM)
		3051	3052	3053	3058	3059	
	MCJT002	7M	14M	14M	21M	21M	
	J09	16	32	32	48	48	PCS

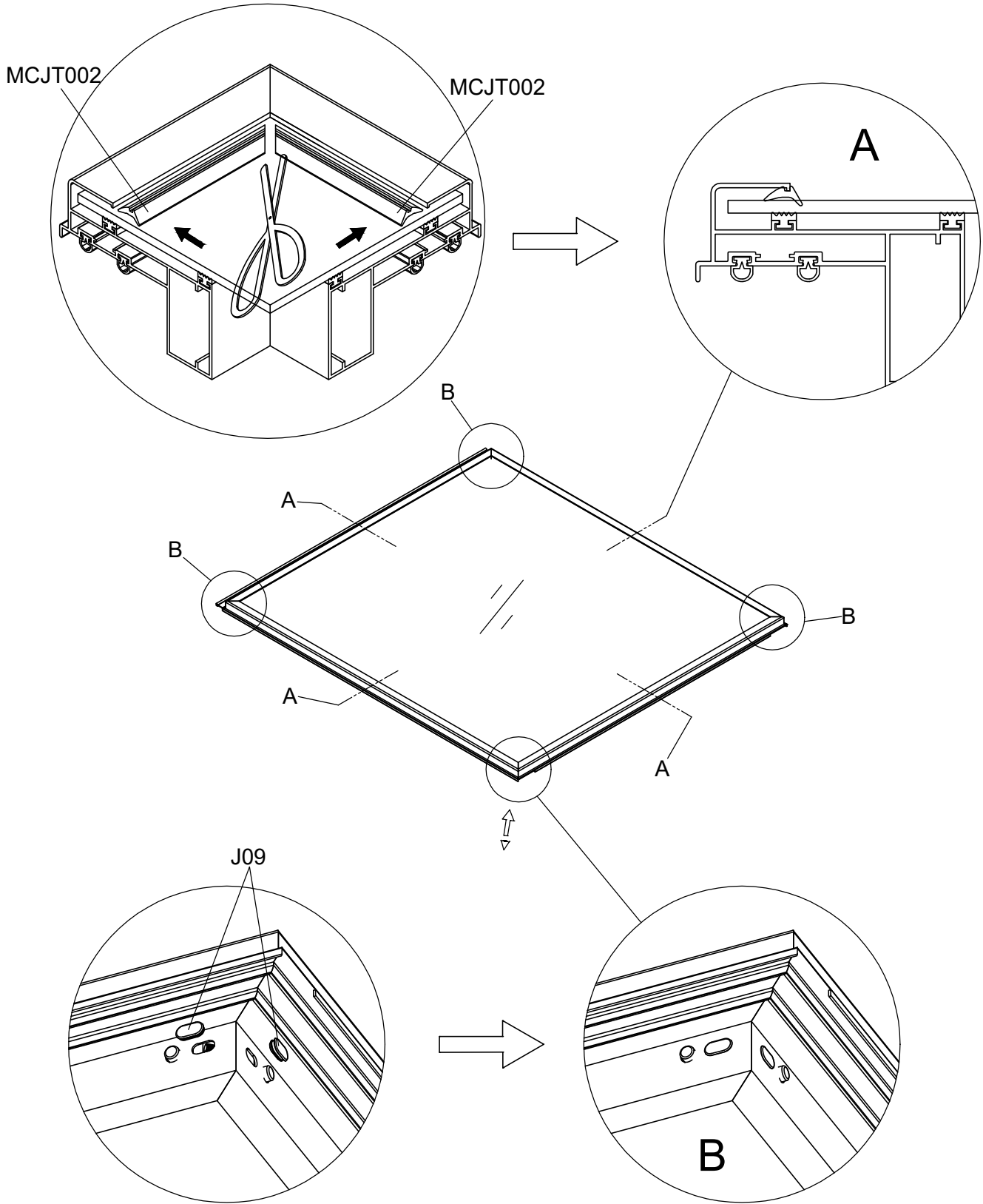

Part	NO.	QTY.					Length(MM)
		3051	3052	3053	3058	3059	
	T07	4	8	8	8	8	PCS

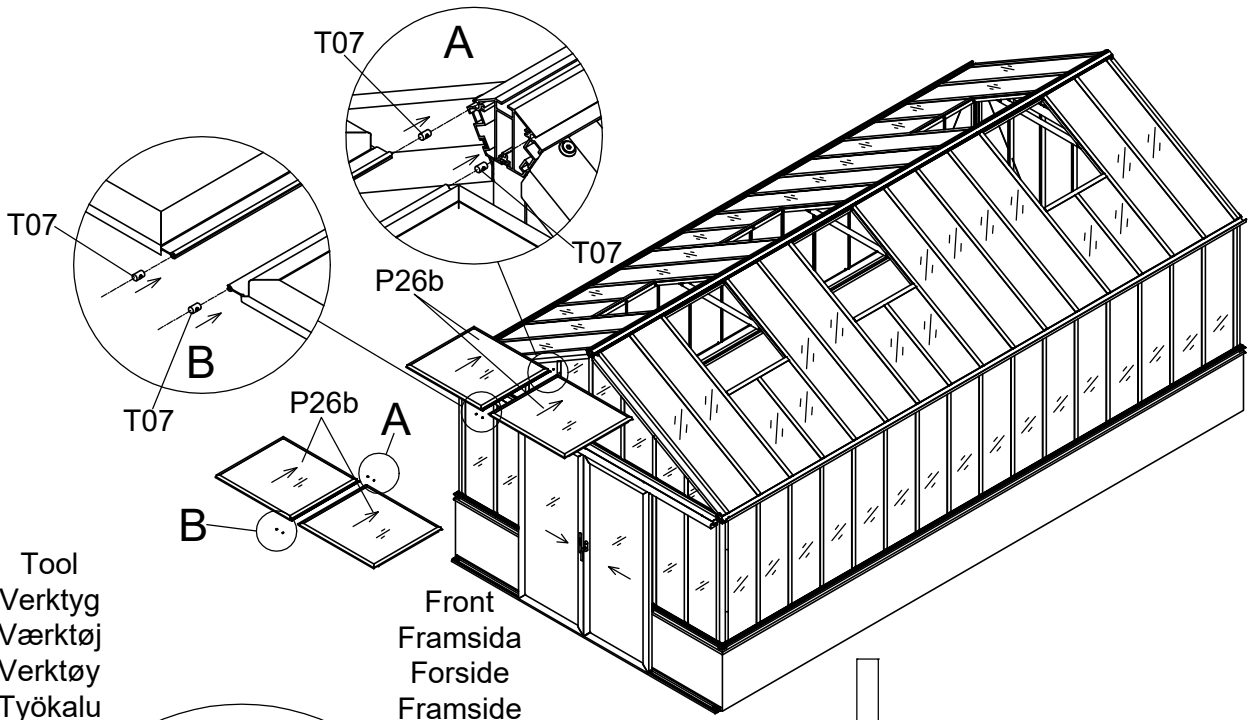

Tool
 Verktøj
 Værktøj
 Verktøy
 Työkalu

Front
 Framsida
 Forside
 Framside
 Etupuoli

Front
 Framsida
 Forside
 Framside
 Etupuoli

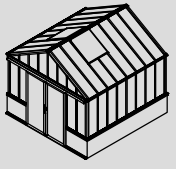
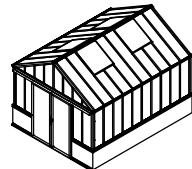
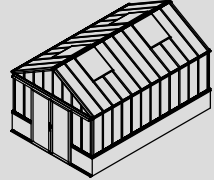
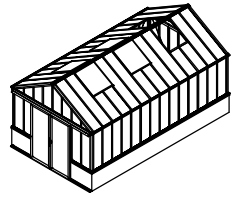
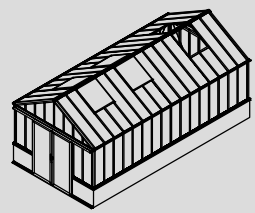
3051	3052	3053	3058	3059
				

Part	NO.	QTY.		Length(MM)
		3058	3059	
	T07	4	4	PCS

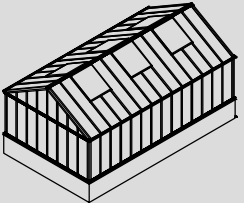
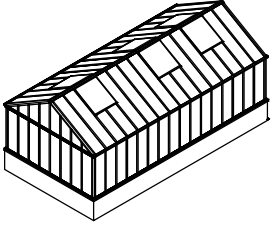
3058	
3059	

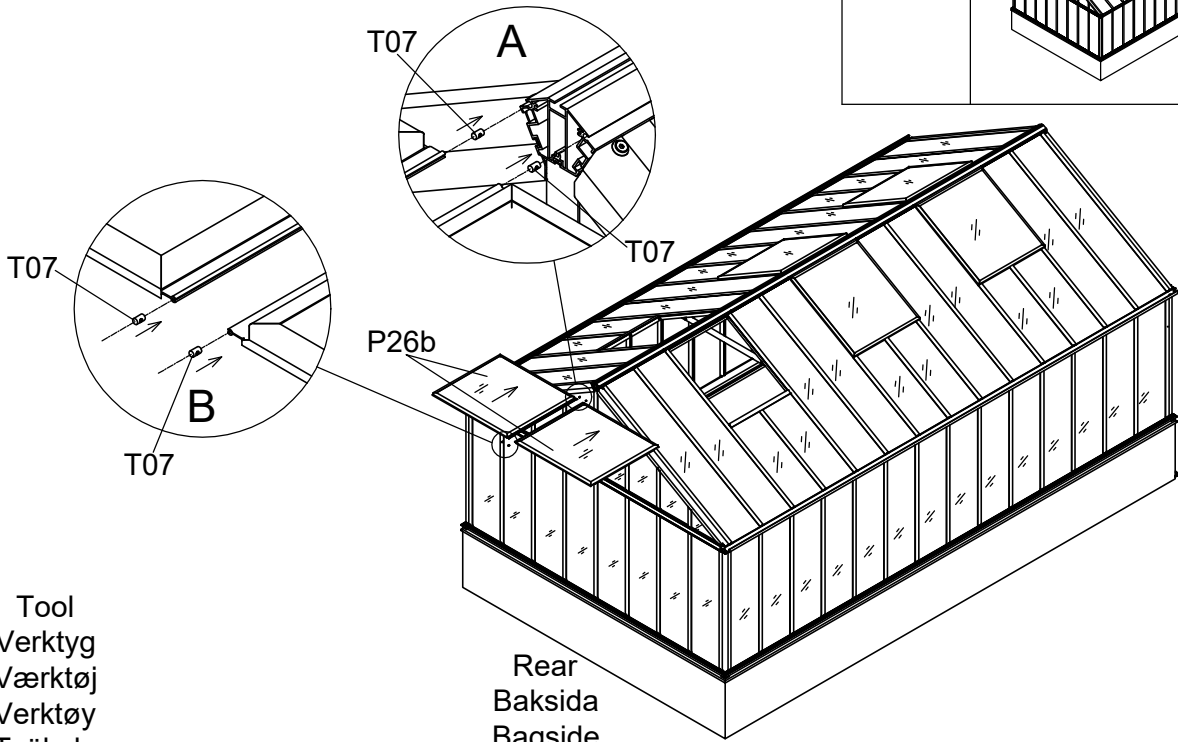

Tool
 Verktyg
 Værktøj
 Verktøy
 Työkalu

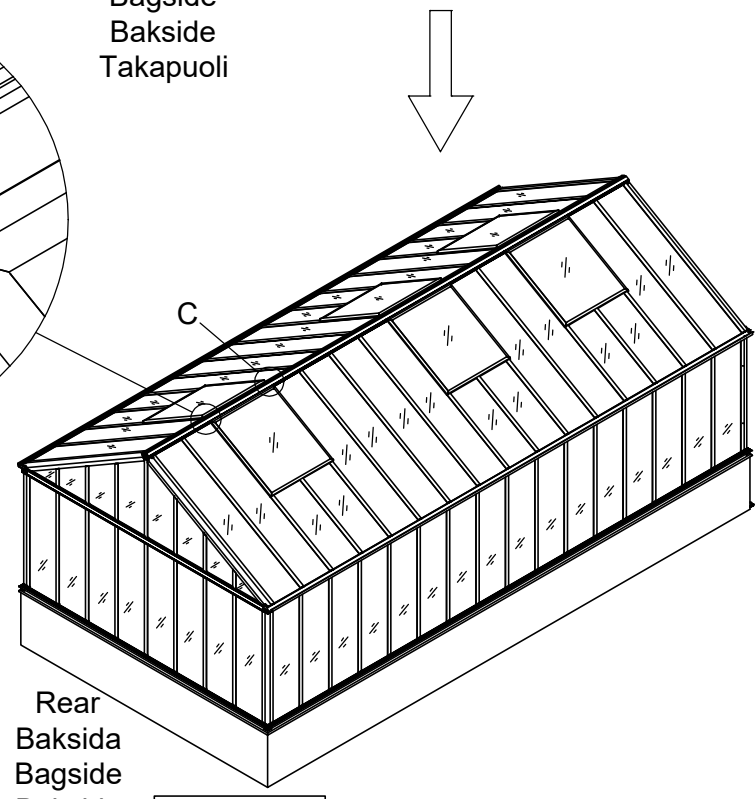
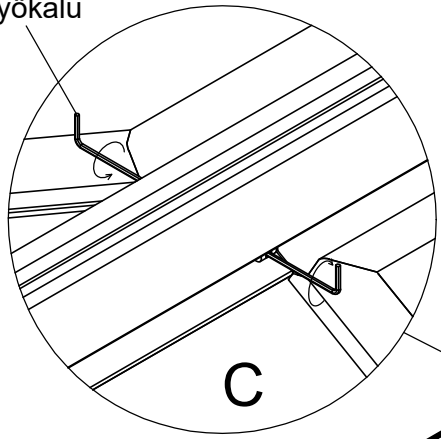





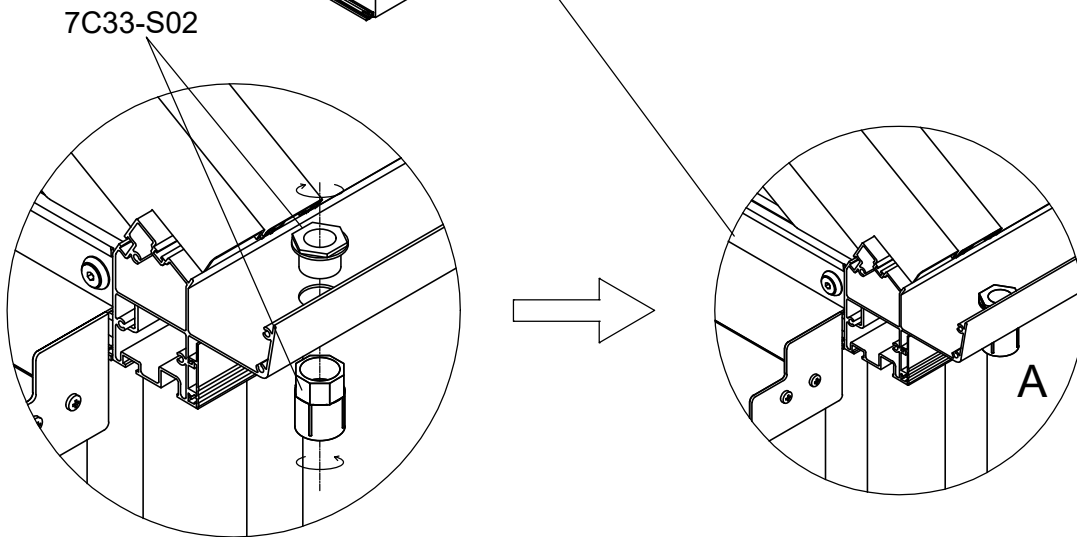
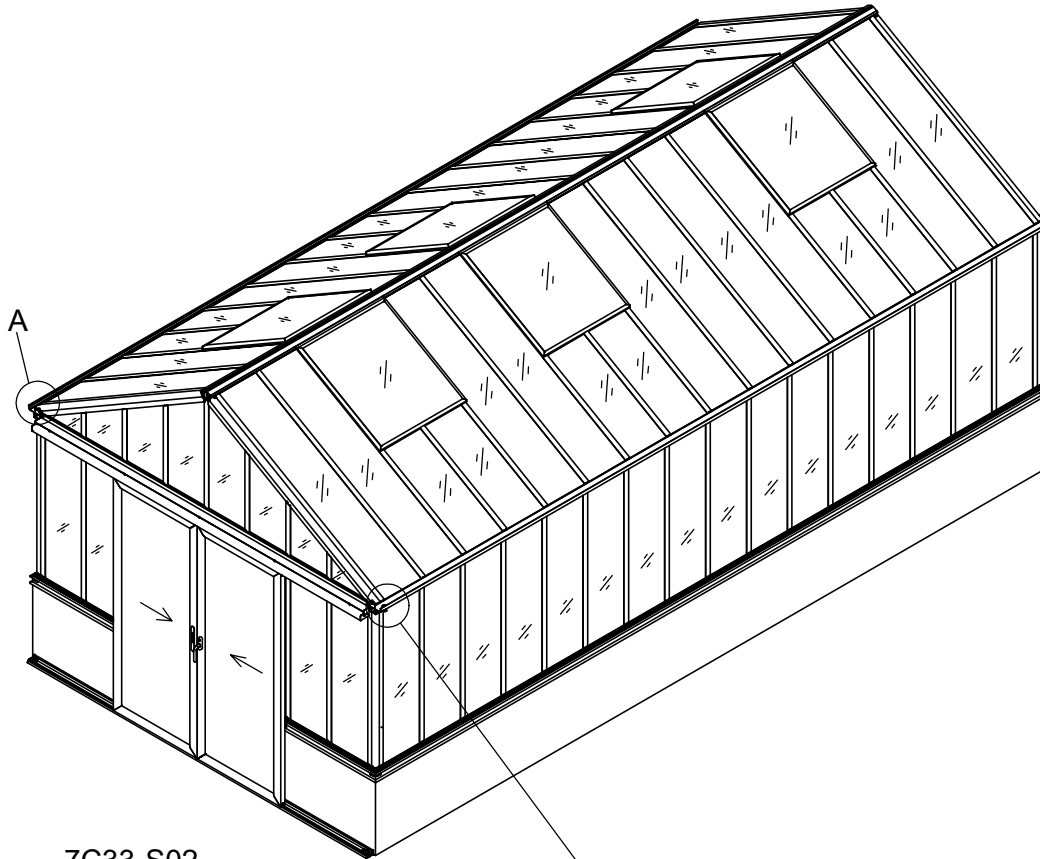

Rear
 Baksida
 Bagside
 Baksida
 Takapuoli

27b/30

Part	NO.	QTY.	Length(MM)
	7C33-S02	2	PCS





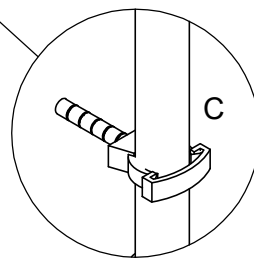
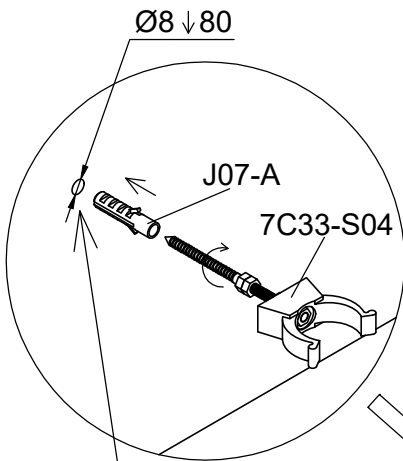
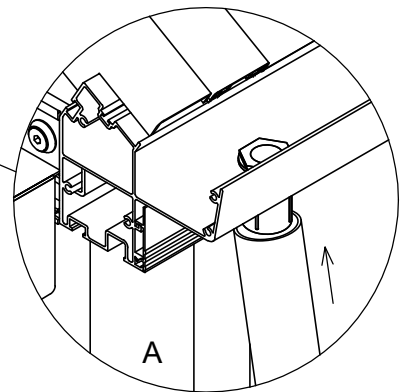
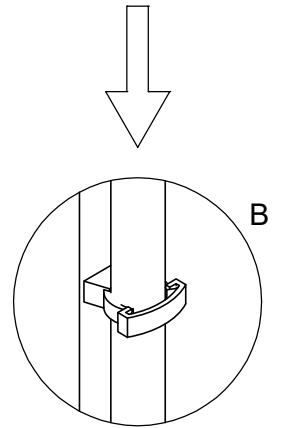
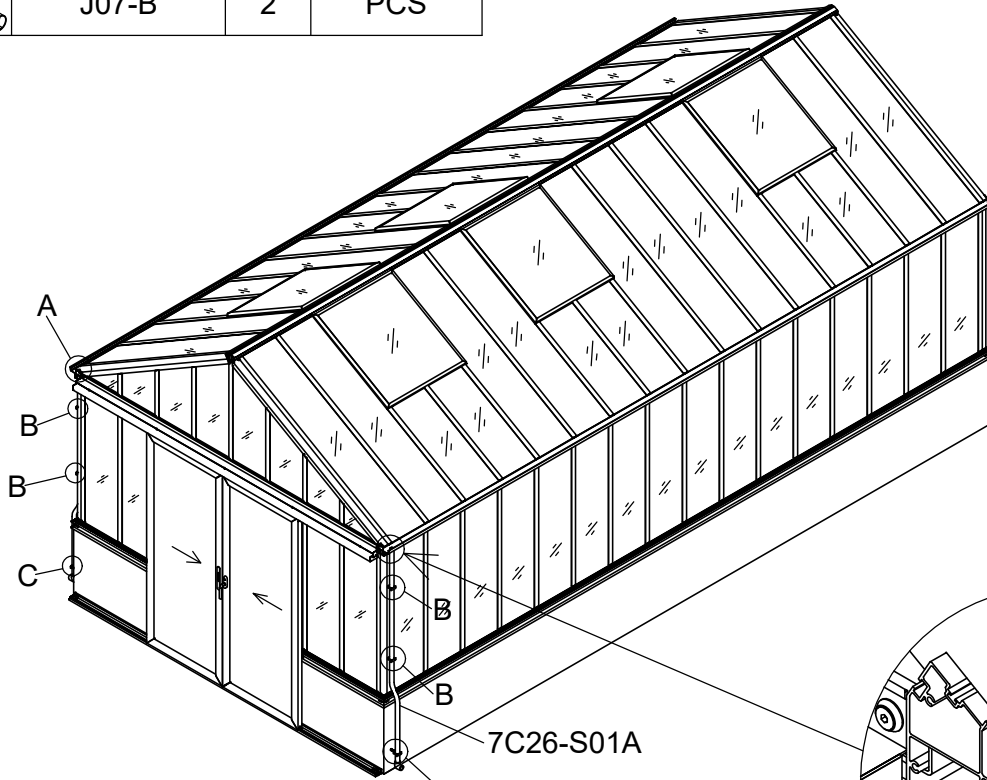
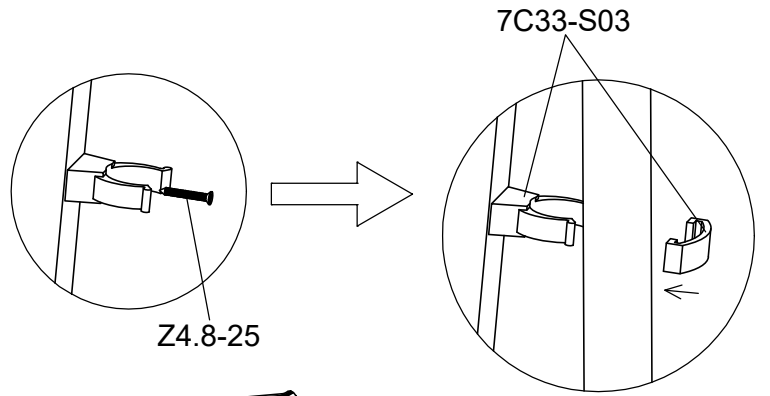

Part	NO.	QTY.	Length(MM)
	7C26-S01A	2	1900
	7C33-S03	4	PCS
	Z4.8-25	4	PCS
	7C33-S04	2	PCS
	J07-A	2	PCS
	J07-B	2	PCS

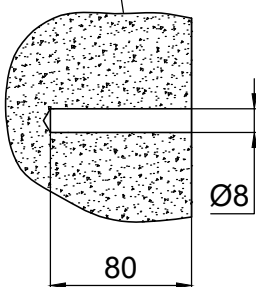
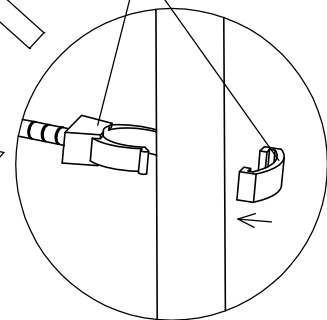
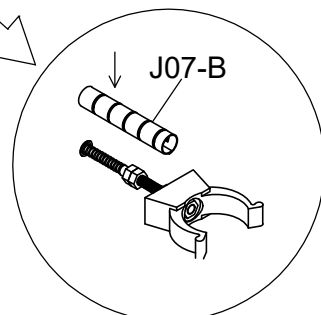

7C33-S04



Part	NO.	QTY.	Length(MM)
	T09	2	PCS
	T10	4	PCS
	T10A	4	PCS
	Z4.2-13	26	PCS

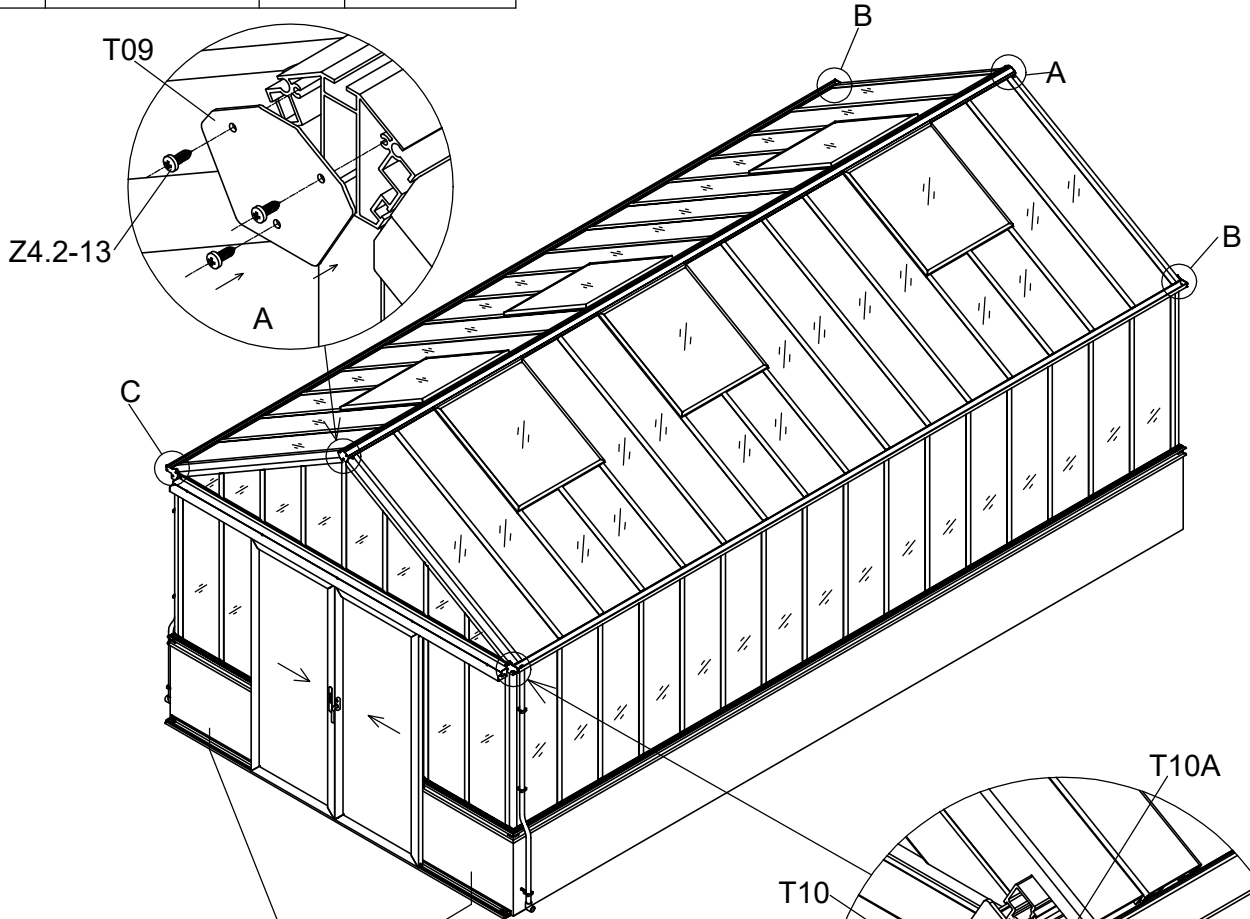

Adjust these door stoppers sideways if you want to open the door larger.

Justera avstånden av dörrstoppen i sidled om ni vill kunna öppna dörrarna ännu mer.

Justere dørstopperne sidelæns, for at give større åbning af døren.

Juster avstanden av dørstopperen sideveis om du vil kunne åpne døren ennå mer.

Säädä liukuovien stoppareiden etäisyys sivusuunnassa, mikäli haluat ovien avautuvan enemmän.

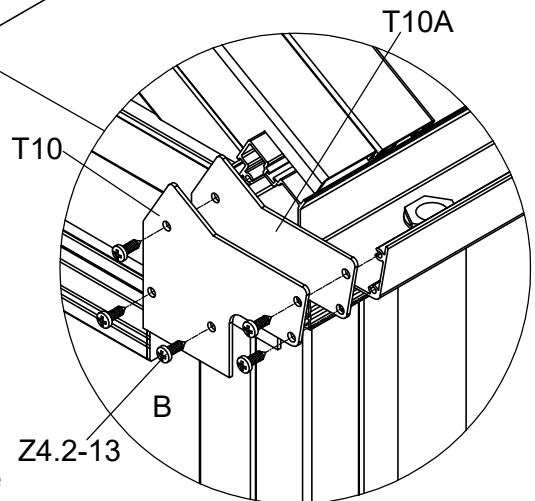

3051

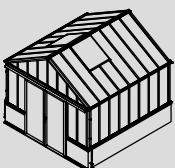

3052

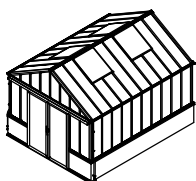

3053

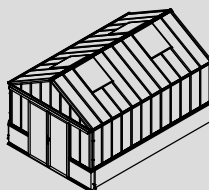

3058

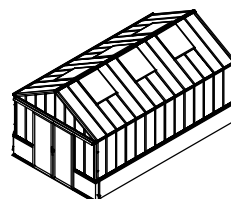

3059

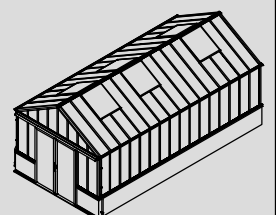



Part	3051		3052		3053		3058		3059		Code
	NO.	Length(MM)	NO.	Length(MM)	NO.	Length(MM)	NO.	Length(MM)	NO.	Length(MM)	
	40A-Y11-4	3173	40A-Y11-5	3924	40A-Y11-6	4675	40A-Y11-7	5426	40A-Y11-8	6177	A001

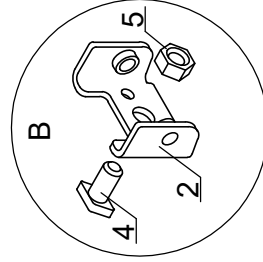
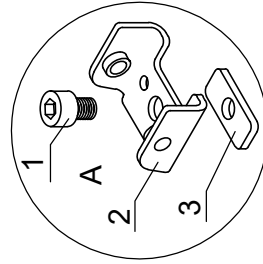
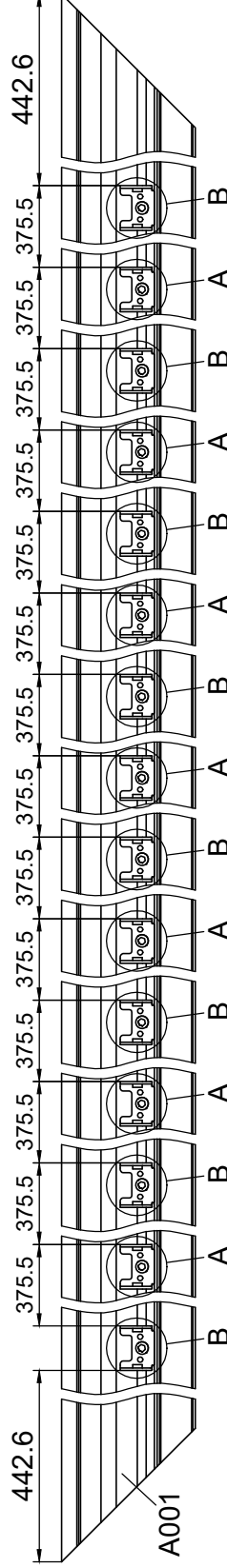

NO.	
1	M6-8
2	7B26-011
3	7B26-025
4	Ma6-12
5	M6

F1

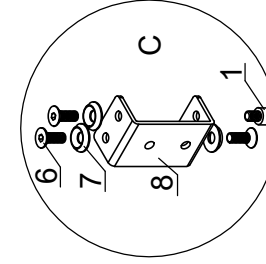
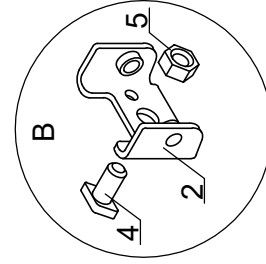
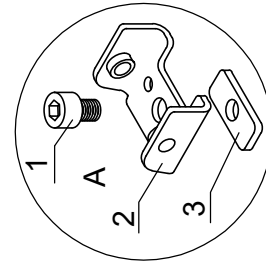
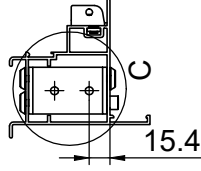
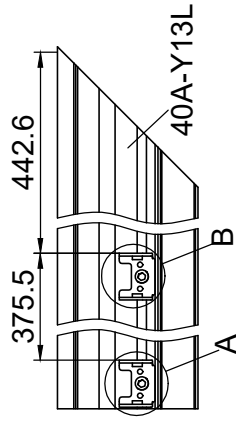
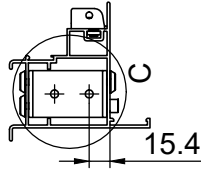
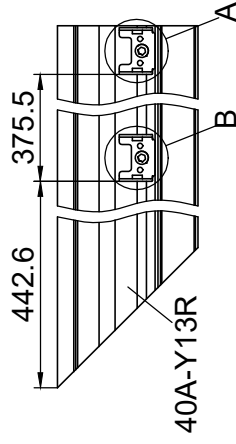
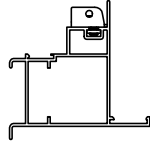
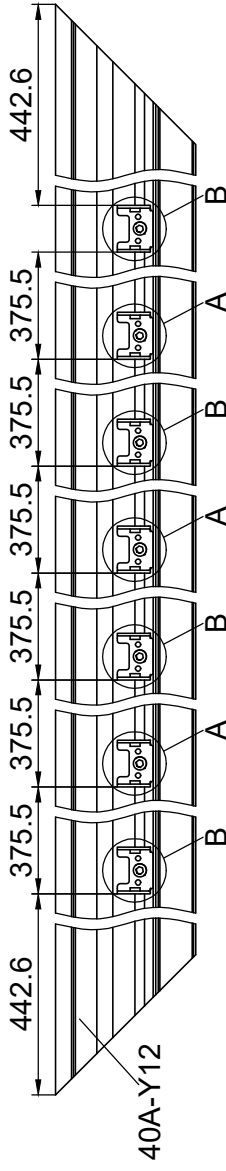

NO.	
1	M6-8
2	7B26-011
3	7B26-025
4	Ma6-12
5	M6
6	Si6-16
7	J05
8	7B26-037A

F2

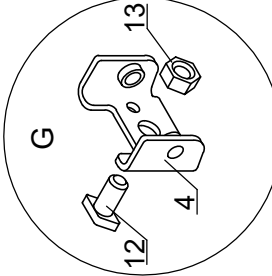
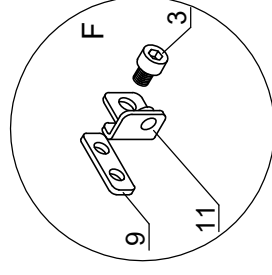
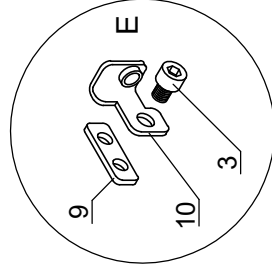
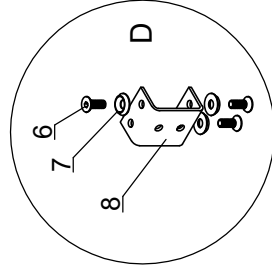
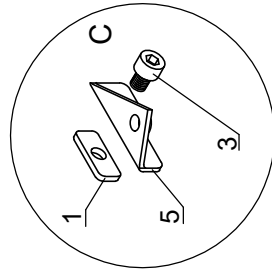
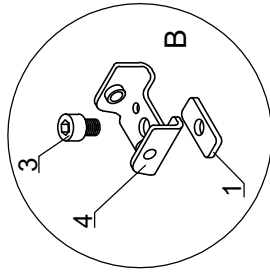
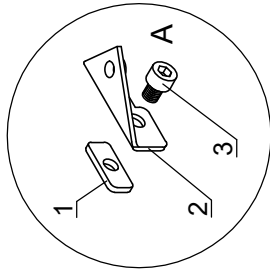
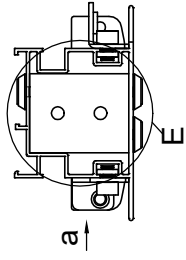
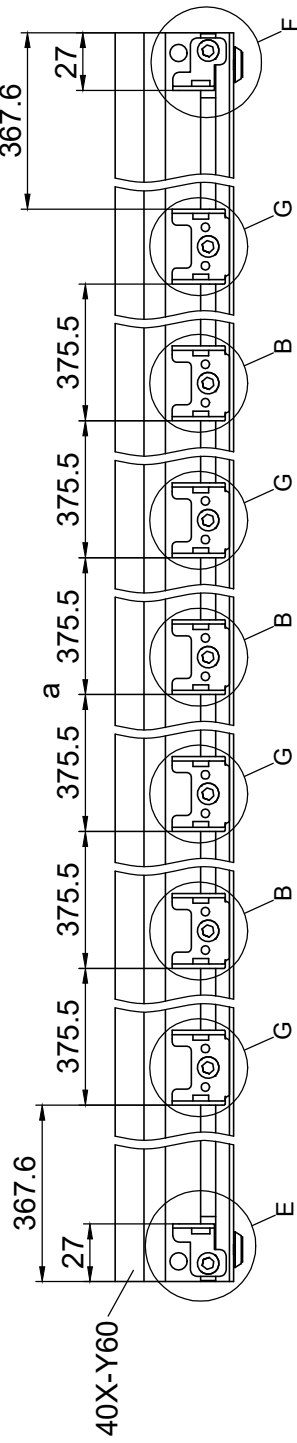
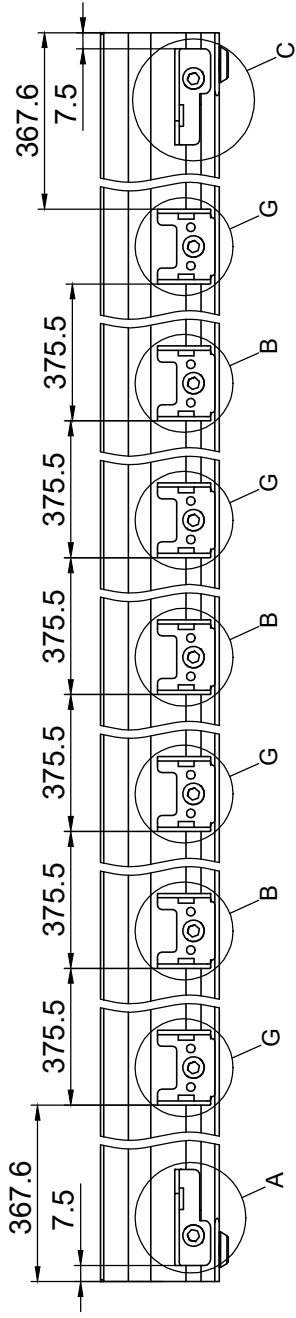

NO.	
1	7B26-025
2	7B26-030
3	M6-8
4	7B26-011
5	7B26-031
6	Si6-16
7	J05
8	7B26-028
9	7B26-033
10	7B26-027
11	7B26-026
12	Ma6-12
13	M6

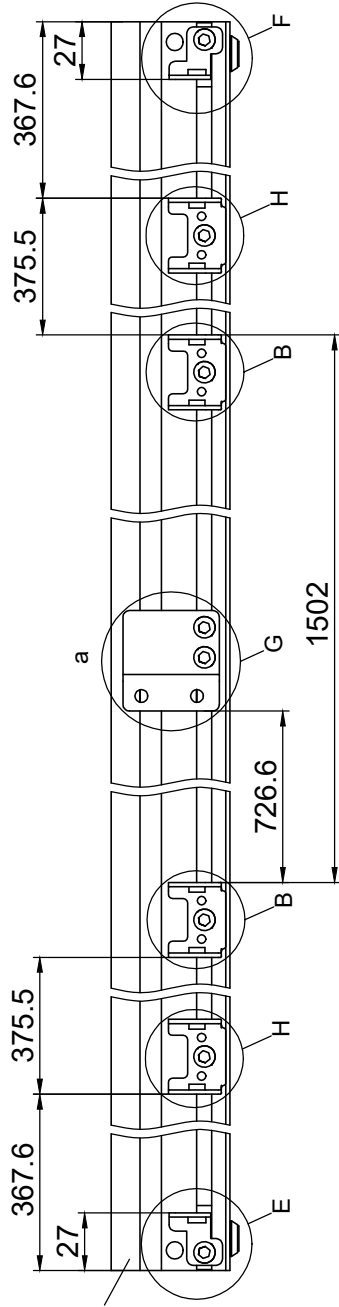
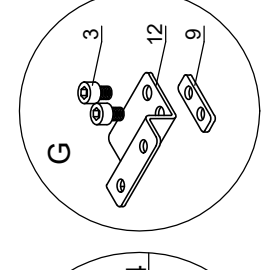
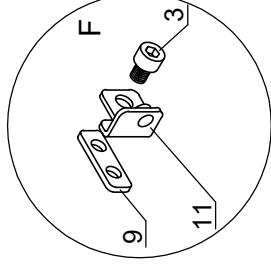
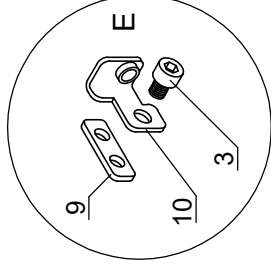
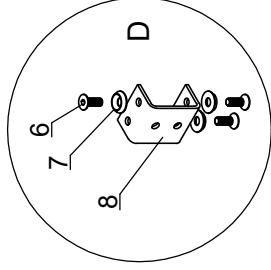
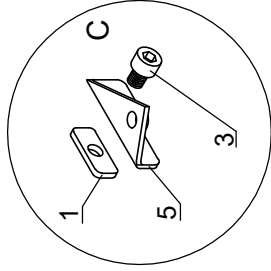
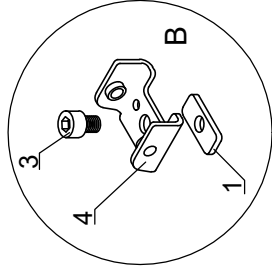
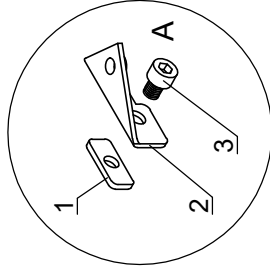
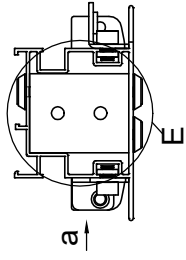
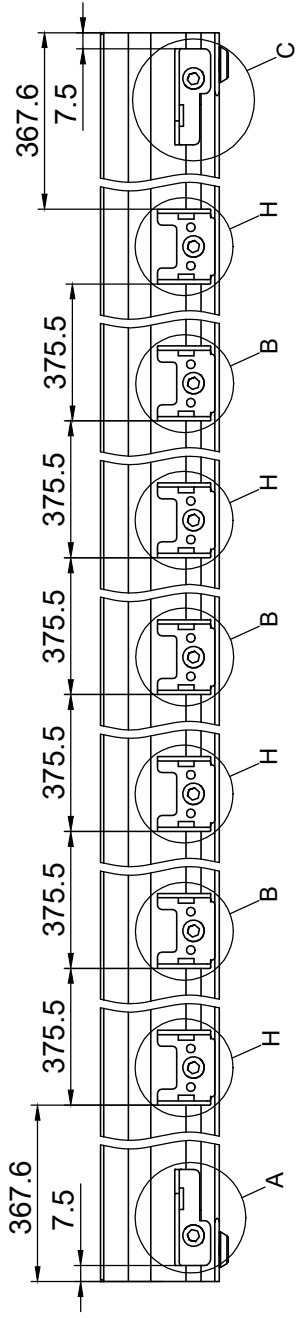

NO.	
1	7B26-025
2	7B26-030
3	M6-8
4	7B26-011
5	7B26-031
6	Si6-16
7	J05
8	7B26-028
9	7B26-033
10	7B26-027
11	7B26-026
12	7B26-036
13	Ma6-12
14	M6

F4



Part	3051		3052		3053		3058		3059		Code
	NO.	Length(MM)	NO.	Length(MM)	NO.	Length(MM)	NO.	Length(MM)	NO.	Length(MM)	
	40X-Y62-4NR	3173	40X-Y62-5NR	3924	40X-Y62-6NR	4675	40X-Y62-7NR	5426	40X-Y62-8NR	6177	A003

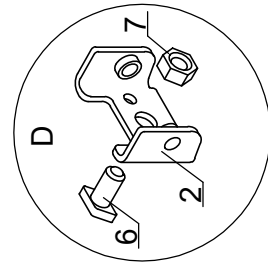
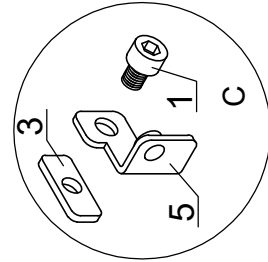
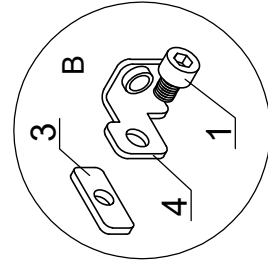
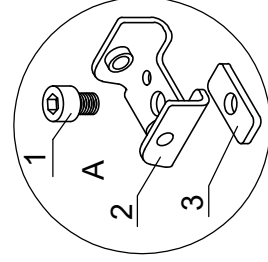
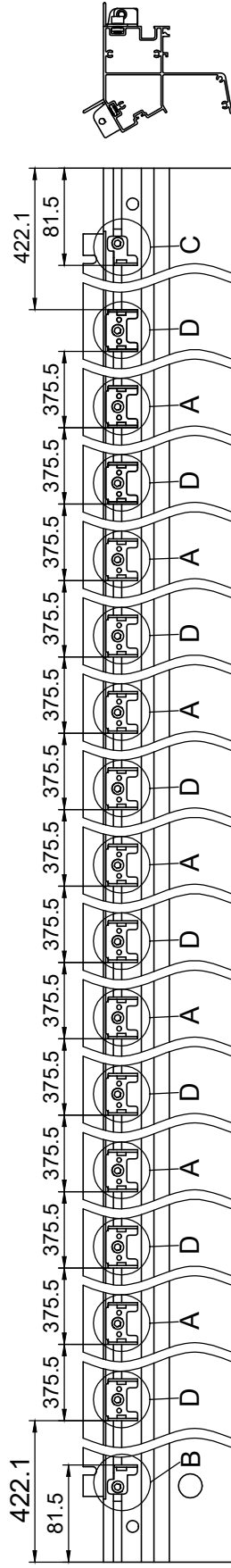
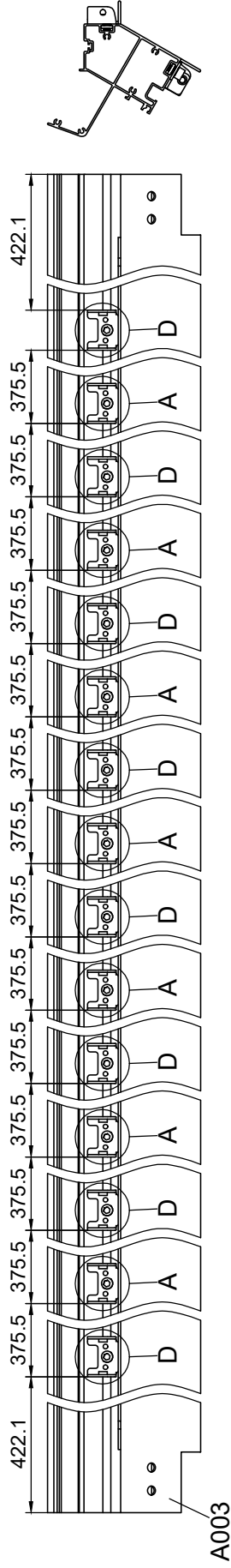

NO.	
1	M6-8
2	7B26-011
3	7B26-025
4	7B26-027
5	7B26-026
6	Ma6-12
7	M6

F5



Part	3051		3052		3053		3058		3059		Code
	NO.	Length(MM)	NO.	Length(MM)	NO.	Length(MM)	NO.	Length(MM)	NO.	Length(MM)	
	40A-Y62-4NL	3173	40A-Y62-5NL	3924	40A-Y62-6NL	4675	40A-Y62-7NL	5426	40A-Y62-8NL	6177	A004

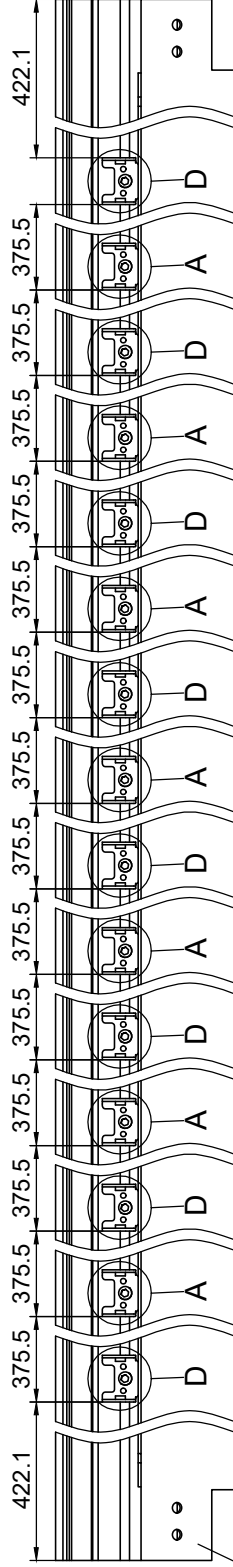

A004

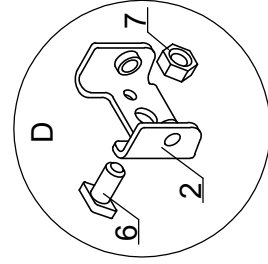
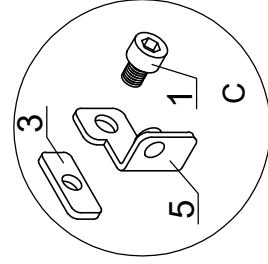
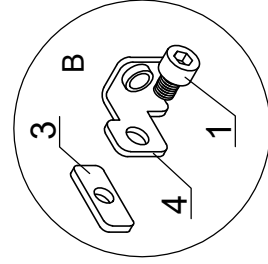
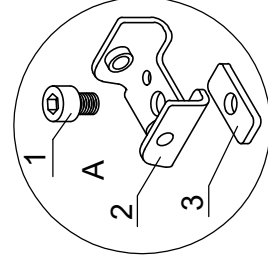
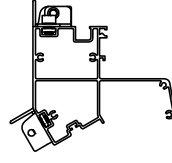
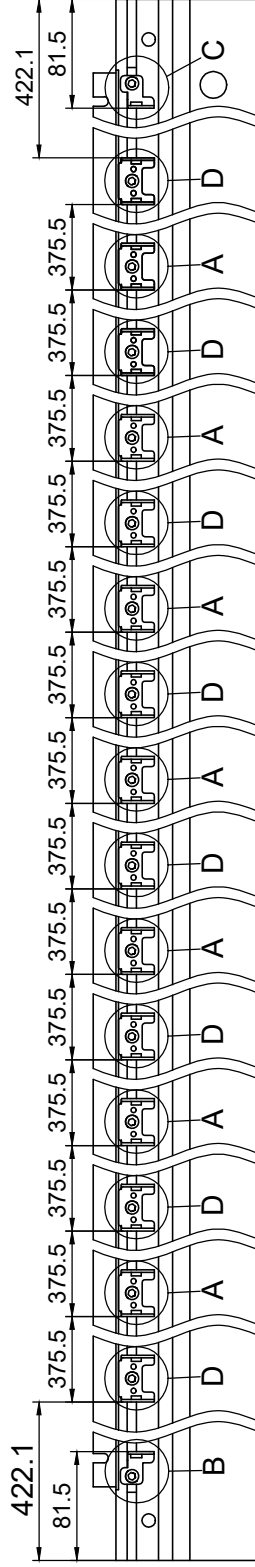
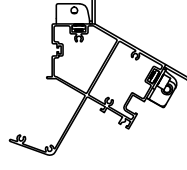

NO.	
1	M6-8
2	7B26-011
3	7B26-025
4	7B26-027
5	7B26-026
6	Ma6-12
7	M6

F6

Part	3051		3052		3053		3058		3059		Code
	NO.	Length(MM)	NO.	Length(MM)	NO.	Length(MM)	NO.	Length(MM)	NO.	Length(MM)	
	40X-Y63-4	3118	40X-Y63-5	3869	40X-Y63-6	4620	40X-Y63-7	5371	40X-Y63-8	6122	A005

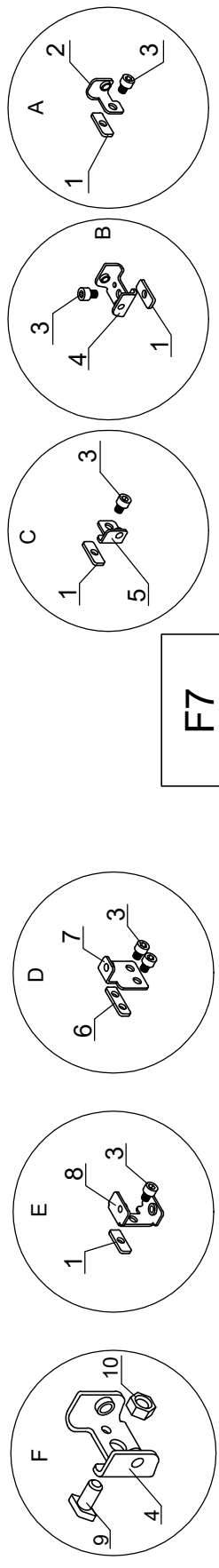
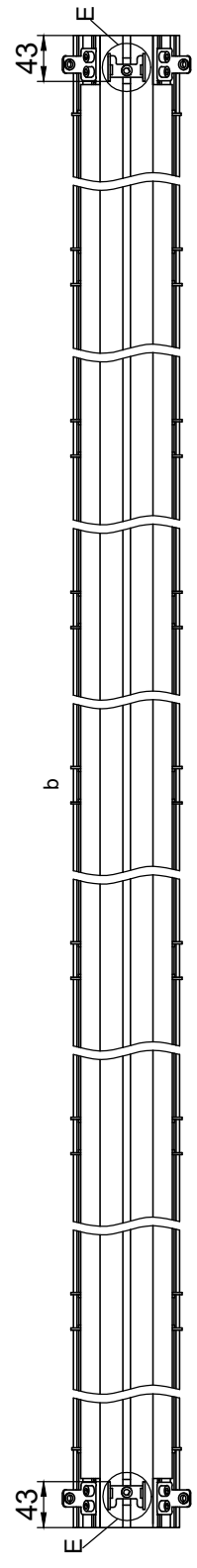
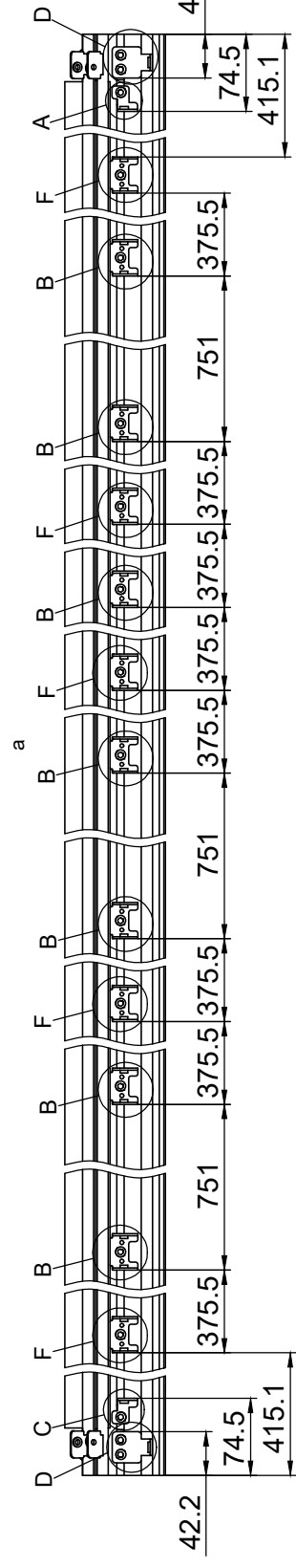
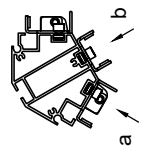
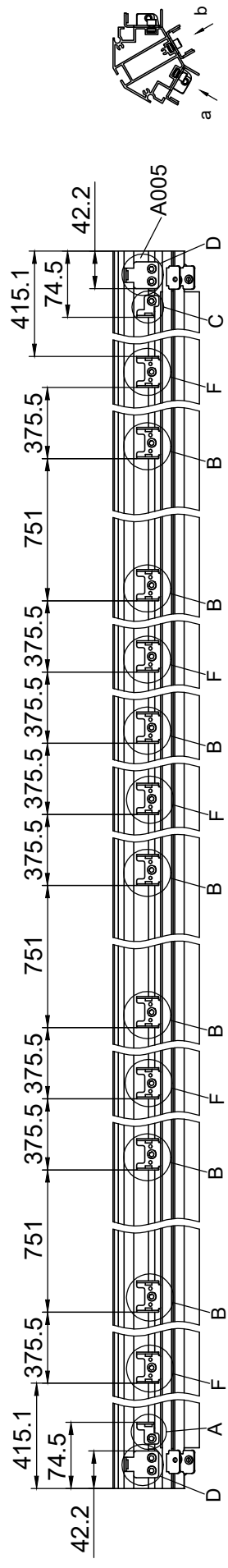
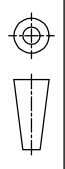

NO.	
1	7B26-025
2	7B26-026
3	M6-8
4	7B26-011
5	7B26-027
6	7B26-033
7	7B26-032
8	7B26-034
9	Ma6-12
10	M6

F7

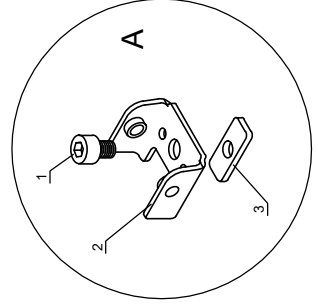
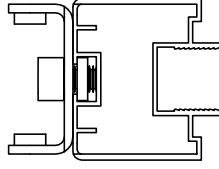
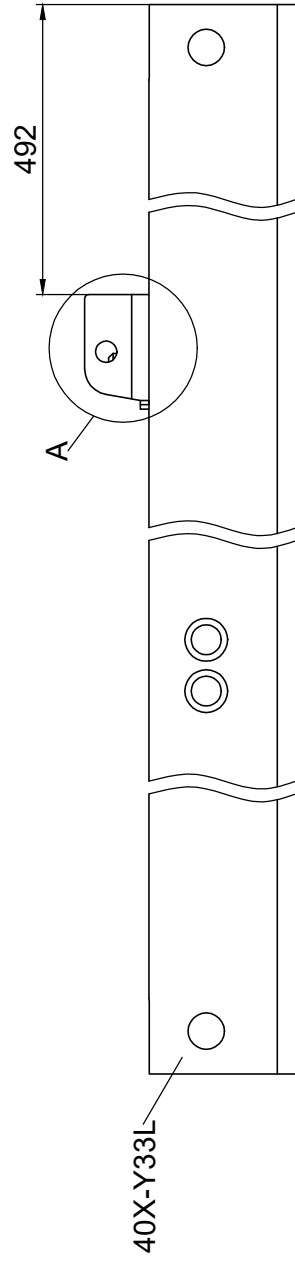
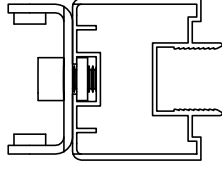
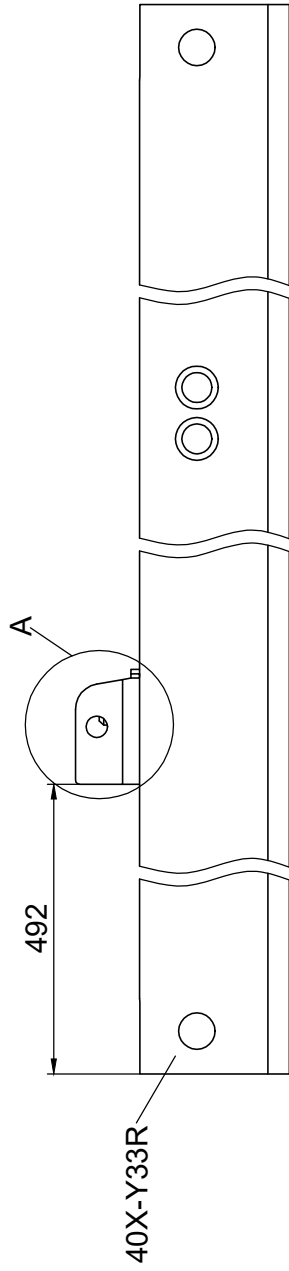
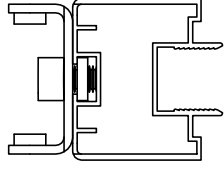
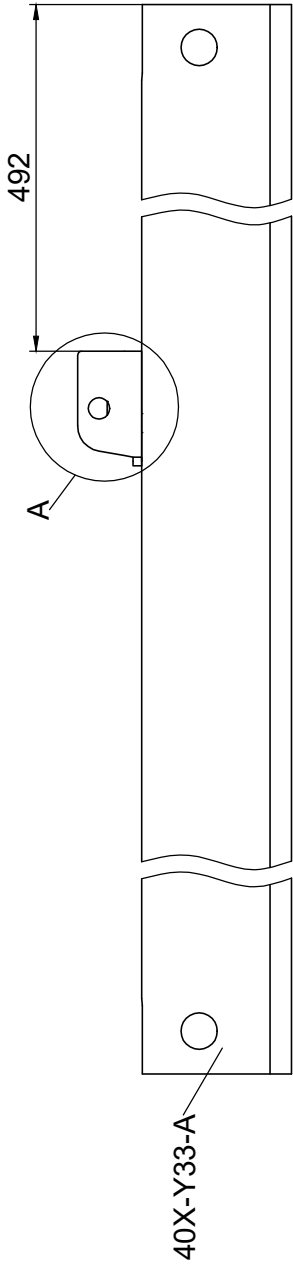

NO.

1 M6-8

2 7B26-011

3 7B26-025

F8